

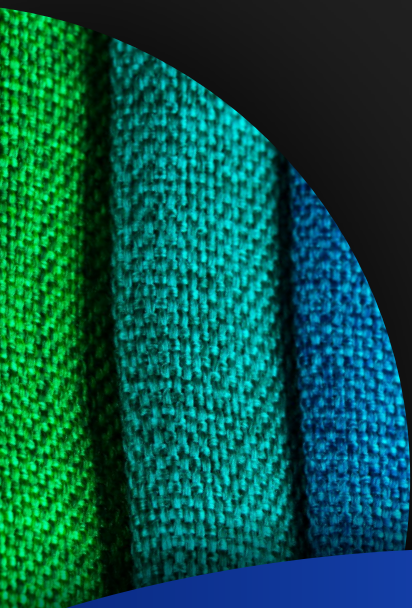

Textile Printing & Drying Solutions

Product Catalogue



www.adelco.co.uk



Drying Solutions

Innovative Drying Systems

We offer a range of versatile textile drying systems, for both conventional and digital ink systems, with different throughput capabilities to suit your business needs.

Page

3-6:	Adelco Pro-Cure Smart
7:	Adelco Pro-Cure Plaiter
8-11:	Adelco Dual Smart
12-15:	Adelco Digi-Cure +
16-19:	Adelco DigiBox
20-23:	Adelco Drawer Drying Cabinets
24-27:	Adelco Roll-to-Roll



Screen Printing Systems

Traditional Ink Machines

A choice of oval and carousel printing systems with unique features to increase throughput efficiency, accuracy and maximise print quality.

Page

28-31:	Adelco Cyclone
32-35:	Adelco Matrix Oval
36-39:	Adelco Ellipse Oval
40-41:	Adelco AD Hybrid Digital
55-56:	Adelco Universal Flash Cure
57-58:	Adelco Hot Air Flash Cure



Digital Printers

Advanced Digital Textile Printers

Discover the digital printing machine for textiles and fabrics with high production capabilities

Page

40-41:	Adelco AD Hybrid Digital
42-43:	Adelco DTF System
46-47:	Adelco UV DTF System



CTS Solutions

Screen exposure units and CTS Systems

Introducing the Adelco CTS system, high precision, high efficiency and with low running cost.

Page

48-49:	Adelco InkPro
48-50:	Adelco LaserPro
51-52:	Adelco Laser
53-54:	Adelco Laser V

Ancillaries

Page

44-45:	Digital Cutter	60:	Stretching & Coating systems
59:	Cyclone Semi-Auto	61:	Exposure, Drying & Screen
59:	Manual Carousel		Washing solutions
59:	Temperature Mapping Kits		
59:	Pre-Registration System		
59:	Table Flash		
59:	Auto Flock Unit		
59:	Flock Cleaner		
59:	Ink Processor		

Adelco China Manufacturing Facility



Adelco China Loading and Shipping Area



Heart of Adelco Production

adelco **smart** PRO-CURE

An advanced textile conveyor dryer that cures both **screen & digitally** printed garments with **four belt width options** to meet your production output requirements.

Standard Features

- Integral infeed and outfeed exhausts
- Four belt widths available
- Ovens are fully modular enabling dryer length to be chosen to suit all curing requirements (expansions available)
- Automatic belt speed control
Just enter the time in minutes and seconds to precisely adjust the speed of your belt
- Triple insulation with air curtain for the coolest exterior shell available
- Air intake from both sides of oven giving unrivaled heat distribution
- Split belt model available on PCS150 & PCS180



New Features

- Ground rubber crowned conveyor rollers, ensures reliable belt tracking, prevent slipping & prolongs conveyor life
- Easy access, removable jet & vacuum plenums enables deep & rapid internal cleaning
- Ergonomically position & fully adjustable HMI control interface
- Rapid dual air filter cleaning
- Rapid infeed and outfeed extraction filter cleaning
- Integrated infeed/outfeed and main blower exhaust with residue trap
- Updated UV flame detection system with easy access
- Built in infeed and outfeed fume extraction system
- On screen temperature mapping
- Curing time and temperature history record
- Gas pressure display
- Fault finding and service instruction videos
- Pit stop internal cleaning
- Quick removable external panels
- Easy clean exhaust drip tray



Optional VOC (Volatile Organic Compounds) exhaust filtration system

The strongest jet airflow on the market with an integrated vacuum utilizes new technology in curing and ink penetration

Recycles clean filtered air

Optional cooling modules and bridges

Small quick release lint filters for simple/fast maintenance, even whilst the dryer is running, no replacement filters required.

Rapid dual air filter cleaning

Sophisticated adjustable touch screen

Easy clean exhaust drip tray

The world's easiest maintainable curing system allows for quick and optimized servicing



Production Capacities (Based on 3 meter oven length)

Model	PCS100	PCS120	PCS150	PCS180
1 minute (Plastisol Ink)	360/hour	720/hour	720/hour	1080/hour
2 mins (Waterbased/Discharge Ink)	180/hour	360/hour	360/hour	540/hour
3 mins (Kornit Digital no white ink/light coloured fabrics)	120/hour	240/hour	240/hour	360/hour
7 mins (Kornit Digital with white ink/dark coloured fabrics)	52/hour	104/hour	104/hour	156/hour

Based on a 3 M oven length. Production increases 30% for a 4 M oven, 60% for a 5 M oven and 100% for a 6 M oven and decreases by 30% for a 2 M oven. Allowing for one line of garments to be placed every 50cm. One line of products on 75cm and 100cm belts, two lines on 120cm and 150cm and three lines on 180cm. Production rates will alter depending on the product placement and the time/temperature settings chosen for the individual curing requirements. Wash tests should be undertaken to ensure the correct time and temperature combination for specific ink types.

Gas Dryer Specifications

Description	PCS100G-3	PCS120G-3	PCS150G-3	PCS180G-3
Electrical Supply Voltages confirmed at time of ordering. Other voltages available on request	3Phase, 50/60HZ 200/220V & 380/415V	3Phase, 50/60HZ 200/220V & 380/415V	3Phase, 50/60HZ 200/220V & 380/415V	3Phase, 50/60HZ 200/220V & 380/415V
Natural Gas Pressure	10" W. G/ 25mbar	10" W. G/ 25mbar	10" W. G/ 25mbar	10" W. G/ 25mbar
Natural Gas Connection	3/4" BSP	3/4" BSP	3/4" BSP	3/4" BSP
Propane Gas Pressure	Line Pressure Reduced to 37mb	Line Pressure Reduced to 37mb	Line Pressure Reduced to 37mb	Line Pressure Reduced to 37mb
Propane Gas Connection	1/4" BSP	1/4" BSP	1/4" BSP	1/4" BSP
BTU REQUIRED	150,000	175,000	200,000	225,000
Time From ambient temp to 160 °C	Approximately 8 mins	Approximately 10 mins	Approximately 12 mins	Approximately 15 mins
Maximum Electrical Consumption	4.5Kw	4.5Kw	4.5Kw	4.5Kw
Exhaust Dia	300mm (12 Inch)	300mm (12 Inch)	300mm (12 Inch)	300mm (12 Inch)

Electric Dryer Specifications

Description	PCS100E-2	PCS100E-3	PCS120E-3	PCS150E-3	PCS180E-3
Electrical Supply Voltages confirmed at time of ordering. Other voltages available on request	3Phase, 50/60HZ 200/220V & 380/415V	3Phase, 50/60HZ 200/220V & 380/415V	3Phase, 50/60HZ 200/220V & 380/415V	3Phase, 50/60HZ 200/220V & 380/415V	3Phase, 50/60HZ 200/220V & 380/415V
Maximum Electrical Consumption	32Kw/h	40Kw/h	40Kw/h	59Kw/h	59Kw/h
Average Electrical Consumption at 180 °C	20Kw/h	28Kw/h	30Kw/h	40Kw/h	40Kw/h
No & KW of Elements	9x3Kw (27Kw)	12x3Kw (36Kw)	12x3Kw (36Kw)	18x3Kw (54Kw)	18x3Kw (54Kw)
Exhaust Dia	300mm (12 Inch)	300mm (12 Inch)	300mm (12 Inch)	300mm (12 Inch)	300mm (12 Inch)

The Adelco Pro-cure Industrial dryer is a highly efficient and economical dryer suitable for virtually all types of screen-printing and digital inks including water based, solvent based and enamel inks and in other screen- printing and industrial applications, including mug and ceramic curing.



The new Adelco Pro-Cure Smart conveyor dryer range is available in four belt widths and five oven lengths, so you can customize your dryer to suit your individual curing requirements, for all digital and conventional textile ink systems. The Pro-Cure Smart is modular in design, making it the perfect option to add additional ovens to the dryer as your business grows.

Designed and specified for advanced textile curing, the Pro-Cure Smart tunnel dryer has an efficient airflow and exhaust system, incorporating oven feed and exit extraction hoods to provide a cleaner working environment. As well as incorporating many of the popular features found in the Adelco Dual Dryer and our other drying systems.

The Adelco Pro-Cure Smart is a feature rich conveyor dryer that uses dual lint filters to prevent the build-up of lint in the dryer and helps to reduce cleaning and maintenance dramatically. Filters can be easily cleaned in seconds while the dryer is still running. With many features included as standard, there are also some optional extras available to enhance your Pro-Cure Smart dryer further.

The Pro-Cure Smart is available as a gas or electric conveyor dryer and uses a sophisticated touch-screen control panel so you can easily set, manage and control the automatic belt speed that is precise and repeatable every time.

The Pro-Cure Smart conveyor dryer offers a split-belt model (only available on PCS150 & PCS180) with two burners, two speeds and two directions, enabling the dryer to cure two independent ink systems at the same time. The Adelco Pro-Cure Smart dryer comes with the strongest, toughest and longest lasting conveyor belts on the market.

PRO-CURE Smart gas dryer consumption analysis

Belt Width	Oven Length	Average Gas Consumption		Average Electric Consumption	
		kg/hr	kwh	kwh	kwh
180cm	3 Meter	2.8	24.5	3.3	
	4 Meter	3.3	29	3.5	
	5 Meter	3.5	31	3.7	
	6 Meter	5.5	48.5	6.5	
150cm	3 Meter	2.6	23	3.2	
	4 Meter	3	26.5	3.4	
	5 Meter	3.2	28	3.6	
	6 Meter	5	44	5.8	
120cm	3 Meter	2.4	21	2.8	
	4 Meter	2.7	24	3	
	5 Meter	2.9	25.5	3.2	
	6 Meter	4.6	40.5	5.0	
100cm	2 Meter	2	18	2	
	3 Meter	2.2	19.5	2.2	
	4 Meter	2.4	21	2.3	
	5 Meter	2.5	22	2.4	
	6 Meter	4.2	37	4.0	

Adelco figures taken from consumption tests, averaged per hour at 160 degrees, with exhaust closed. Consumption figures can change according to local environment, production throughput, ink and product types. Adelco reserve the right to revise or review these figures as required.

PRO-CURE Smart Airflow

Figures shown are hot air oven (curing air volume) only and do not include integral exhaust hoods.

Model	Main Fan Specification	Pulley Ratio	RPM	Air Speed	Max Airflow
PCS100-3	400*400	100:132	1100	25 m/s	5,800 CFM
PCS100-4	400*400	100:118	1230	28 m/s	6,500 CFM
PCS100-5	400*400	118:118	1450	30 m/s	7,000 CFM
PCS100-6	400*400	118:118	1450	30 m/s	7,000 CFM
PCS120-3	400*400	100:132	1100	25 m/s	5,800 CFM
PCS120-4	400*400	100:118	1230	28 m/s	6,500 CFM
PCS120-5	400*400	118:118	1540	30 m/s	7,000 CFM
PCS120-6	400*400	118:118	1450	30 m/s	7,000 CFM
PCS150-3	400*400	100:118	1230	28 m/s	6,500 CFM
PCS150-4	400*400	118:125	1370	29 m/s	6,750 CFM
PCS150-5	400*400	118:118	1450	30 m/s	7,000 CFM
PCS150-6	400*400	118:118	1450	30 m/s	7,000 CFM
PCS180-3	400*400	100:118	1230	28 m/s	6,500 CFM
PCS180-4	400*400	118:125	1370	29 m/s	6,750 CFM
PCS180-5	400*400	118:118	1450	30 m/s	7,000 CFM
PCS180-6	400*400	118:118	1450	30 m/s	7,000 CFM

adelco smart plaiter PRO-CURE

An advanced textile conveyor dryer that cures both screen & digitally garments with four belt width options to meet your production output requirements and a plaiter that carefully folds fabrics.

Features

- Ovens lengths are fully modular to suit any curing requirements.
- The dryer syncs with the printer automatically, adjusting speeds accordingly.
- Triple insulation with air curtain for the coolest exterior shell available.
- Plaiter widths available at 1.8m, 2.7m & 3.2m

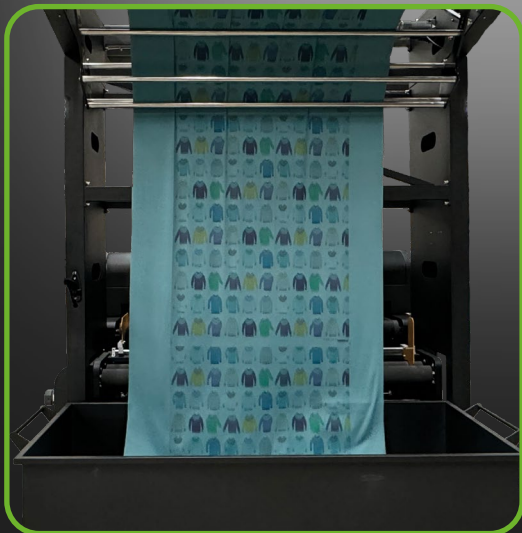

Plaiting offers key benefits over roll-to-roll dryers. It prevents curling and tension issues, allowing the fabric to lay flat and avoid distortions that can complicate processing. Plaiting also reduces wrinkles and creases by minimizing pressure points, especially in delicate fabrics.

Fabric plaiter designed to delicately fold materials, available in the following widths 1.8m, 2.7m & 3.2m options.

adelco **DUAL** smart

The world's highest production and most **energy efficient dual conveyor** dryer for curing screen & digital ink systems.

Adjustable touch screen control panel

Independent temperature control for both levels

Automatic self-tensioning conveyors



**Two Dryers,
One Footprint.**

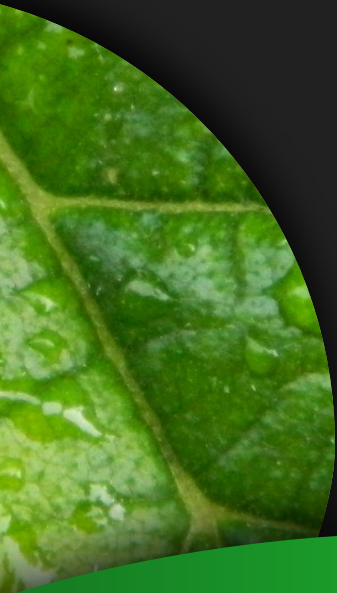

The Adelco Dual Smart has a unique built in extraction system on the infeed and outfeed for a cleaner working environment together with independent exhaust extraction from each conveyor to maximize the curing efficiency for heavily water laden prints in both digital and conventional printing requirements.



Single internally integrated burner exhaust & extraction with residue trap

Advanced airflow system incorporating high powered jet air and integrated vacuum pull down on both levels

Independent belt speed control to both levels

Easy to remove external panels

- The Dual Smart dryer from Adelco takes high production curing to a new level, with independent burners and temperature control for each conveyor
- The Dual Smart is now modular & can be extended with a dual deck drone to 4 metres
- Ergonomically positioned & fully adjustable HMI control interface
- On screen gas pressure display
- New Non Slip Conveyor belts
- Self-tensioning, self-aligning conveyor belts
- Ground rubber crowned conveyor rollers ensure reliable belt tracking, prevents slipping & prolongs conveyor life
- Easy access, removable jet & vacuum plenums enables deep & rapid internal cleaning

- Easy access air filter cleaning
- Easy access infeed and outfeed extraction filter cleaning
- Exhaust residue trap
- Independent burners and airflow for each belt
- Updated quick access UV flame detection system
- Built in infeed/outfeed fume extraction system
- Curing time and temperature history report
- On screen temperature mapping (via optional temp mapping device)
- On screen fault finding and service instruction videos
- Pit stop internal cleaning
- Easy to remove, tool free external panels

High Performance

High Production

Low Cost

Low Emissions

Description	DS-180G-3	DS-180G-4	DS-180E-3 & 4
Gas Pressure Input Natural	10"W.G/25mbar/each supply	10"W.G/25mbar/each supply	/
Gas Pressure Input Propane	Line Pressure (reduced to 37mbar)/each	Line Pressure (reduced to 37mbar)/each	/
Gas Connection Natural	3/4"BSP/each	3/4"BSP/each	/
Gas Connection Propane	1/4"BSP/each	1/4"BSP/each	/
Electrical Supply	3 Phase 220V/380V/415V	3 Phase 220V/380V/415V	3 Phase 220V/380V/415V
Max Electrical Consumption	7KW	7KW	79 KW
Time from ambient temp to 160°C (320°F)	Approximately 15 minutes	Approximately 20 minutes	/
Exhaust Diameter	(12"BSP)300m	(12"BSP)300m	(12"BSP)300m
Maximum BTU Required	250,000 btu / 7 meters cubed per hour (the heat capacity of our burners exceed the maximum supply used to ensure the most efficient and effective utilisation of heat)	250,000 btu / 7 meters cubed per hour (the heat capacity of our burners exceed the maximum supply used to ensure the most efficient and effective utilisation of heat)	Average Electrical Consumption at 180 °C: DS180E-3 - 60 KW/H DS180E-4 - 68 KW/H
Average BTU Consumption	117,000 btu / 3.3 meters cubed per hour (calculated with a full belt of printed shirts, in production)	156,000 btu / 4.4 meters cubed per hour (calculated with a full belt of printed shirts, in production)	No & KW of electric elements: 24 off 3 KW

Time	Digital Print (Black Shirts)	Screen Print
1 Minute	/	2160 per hour
2 Minutes	/	1080 per hour
5 Minutes	430 per hour	
6 Minutes	360 per hour	
8 Minutes	270 per hour	
10 Minutes	216 per hour	

Based on three lines of adult size garments across each belt width. Allowing for one product placed every 50cm. Production rates will alter depending on product placement and time/temperature settings chosen for individual curing requirements.

Dual Smart Airflow

Model	Main Fan Specification	Pulley Ratio				RPM		Air Speed	Max Airflow
		Upper Level 50HZ	Upper Level 60HZ	Lower Level 50HZ	Lower Level 60HZ	Upper	Lower		
DS180-3	400*400 x 2	100:118	100:132	100:100	100:118	1180	1400	26 m/s	6,000 CFM
DS180-4	400*400 x 2	100:118	100:132	100:100	100:118	1180	1400	26 m/s	6,000 CFM

Figures shown are hot air oven (curing air volume) only and do not include integral exhaust hoods.

The Adelco Dual Smart dryer gets its name from its unique design. The Dual Smart dryer is a double belt conveyor dryer with separate heat chambers, airflow and exhaust systems for the top and bottom conveyor belts.

Experience the benefits of two dryers in one footprint with the Adelco Dual Smart dryer range. With dual tunnels, the Dual dryer increases the high throughput capabilities in both digital and conventional textile print requirements, without increasing the size of the dryer.

With independent burners, time and temperature controls for each conveyor level, the Dual Smart cures digital and screen-printing inks in high volumes with such a small footprint.

All Adelco drying machines, including the Dual Smart, and the range of Pro-Cure Smart dryers, are fitted with internal exhaust hoods over the feed and exit sections of the oven. This provides a cleaner working environment without having to add optional extraction hoods and exhaust connections.



“Mark and Leigh Smith have been in the industry a long time and are the only owner-owned manufacturer/distributors in the industry. They’ll look at what you need and will then create a solution for you, rather than trying to find a product to fit you. That makes a huge difference. We’ve got six Ecotexes now and three Duals. The Dual is amazing, you can get a huge volume of digital through a very small area. And Steve, who’s their main engineer, he’s just brilliant, he really knows these machines.”

- Andy, T Shirt & Sons. UK

adelco DIGI-CURE +

A **small dryer** with big dryer features and **performance.**

Heating element monitoring & on screen notifications

Maximum curing ability with minimum effect to fabrics

Compact & streamline design

Automatic belt speed control in minutes and seconds

Easy access main isolator

80cm wide conveyor belt



Economical.

Full 2.6m curing ability

Integrated infeed/outfeed extraction

Integrated exhaust and fan

The Adelco Digi-Cure + is our updated solution for small to medium production lines.

This small but mighty Digi-Cure textile conveyor dryer is aimed at providing great value with excellent curing ability for all textile ink systems, both digital and conventional as well as transfers.

The Digi-Cure + has twin fans that provide double the airflow compared with its predecessor, offering the highest airflow performance of a small dryer.

The Digi-Cure + conveyor dryer is 2.6 meters long with a 90cm in-feed and 90cm out-feed, with a 80cm belt width.

A sophisticated touch screen control panel, giving total control over the curing time, temperature and maintenance, as well as dryer fault diagnosis in seconds.

A new exhaust and drip tray located on the edge of the dryer, enables easy access and cleaning. Infeed and outfeed fume extraction for a cleaner production environment.

Maintenance and accessibility is now effortless with screwless, quick release panels, easy access filters and mesh replacements, saving money and resources.

The Digi-Cure + comes with many unique and advanced features that will boost efficiency, conserve fuel and improve the longevity of the print and the dryer.

High pressure airflow for best possible curing penetration

Exhaust oil drip tray

HMI control panel with fault diagnosis & automatic digital belt speed in minutes & seconds

Fume extraction system

Conveyor tracking system

adelco DIGI-CURE

adelco

4.60m

Slide out air filter

Tool free removable panels

Model No	DC+80E-3
Electrical Supply	22kW, 3 Phase 220-240V or 380V-415V, 50/60hz
Belt Speed	50 secs > 10 mins
Time from ambient temp to 160°C (320°F)	Approx 30 mins
Exhaust Diameter	200mm (8")
Belt Width	80cm (32")
Infeed/Outfeed	88.5cm (35")
Oven Length	260cm (102")
Oven Dimensions (max)	115cm (45") W x 127cm (50") H x 260cm (102") L

Time	Digital Print (Dark Shirts)	Digital Print (Light Shirts)	Screen Print
1 Minute	/	/	300 per hour
2 Minutes	/	150 per hour	150 per hour
3 Minutes	/	100 per hour	100 per hour
4 Minutes	75 per hour	75 per hour	/
5 Minutes	60 per hour	/	/
6 Minutes	50 per hour	/	/
7 Minutes	45 per hour	/	/
8 Minutes	40 per hour	/	/

Based on a single line of adult size garments, allowing for one product placed every 50cm. Production rates will alter depending on product placement and time/temperature settings chosen for individual curing requirements.



“Adelco keeps up with technology and the temperature keeps constant. Service with Adelco is brilliant, Steve looks after us and is always on hand to help out either on the phone or getting stuck in the machines.”

- Pally Hayre, Pally UK

adelco DIGIBOX

The New Digibox is equipped with all the standard features of higher priced hot air conveyor dryers and is designed to grow as you do, with 1 meter oven increments.

The Digibox is perfect for curing all Screen and Digital textile inks.

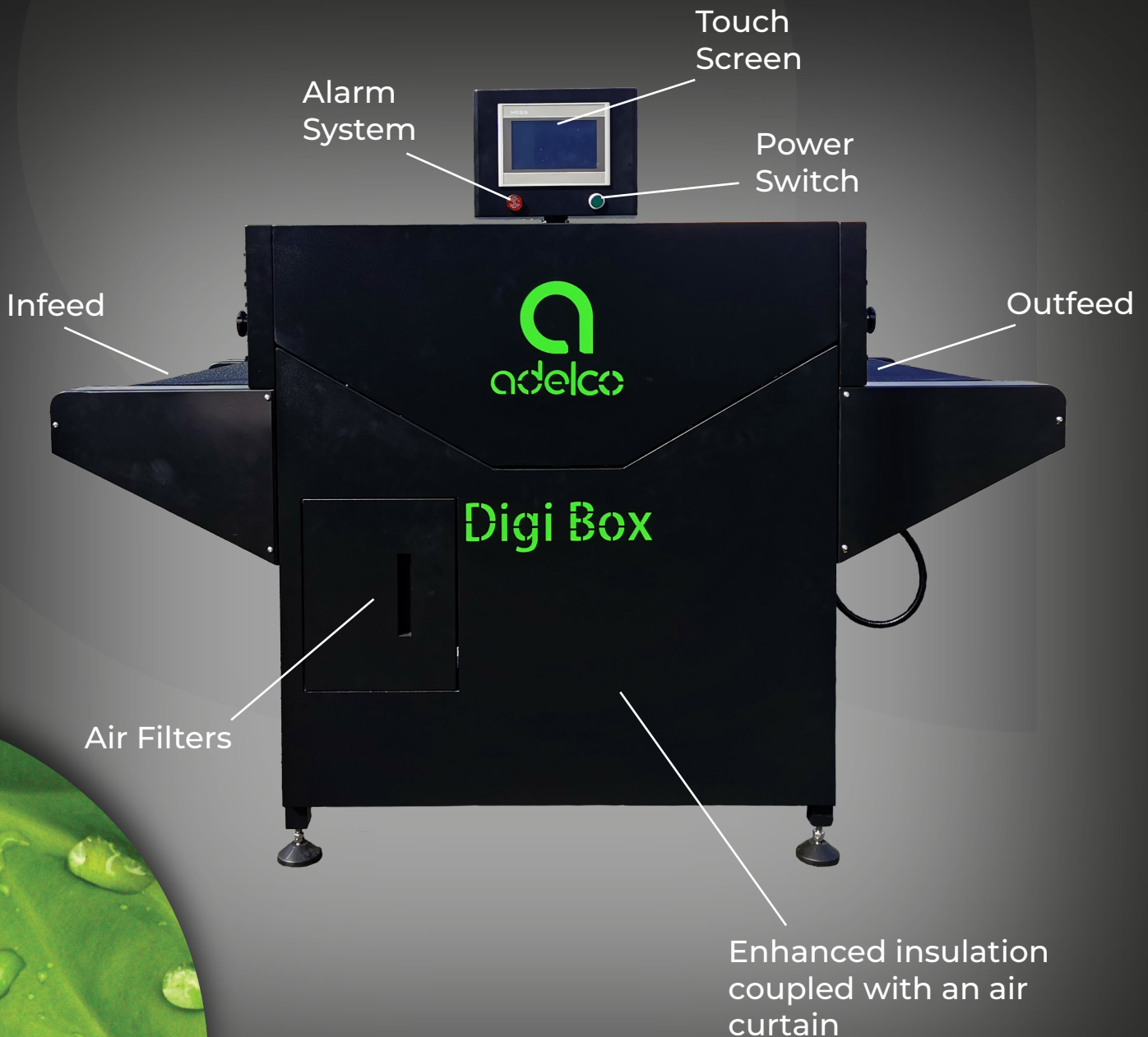

Key Features

- 1-meter curing capacity and limitless modular expansion.
- Optimal curing efficiency while minimizing impact on fabrics.
- Streamlined and compact design
- Automatic belt speed control down to the minutes and seconds.
- Conveyor belt width of 80cm.

Additional Functions

- Boasts the features and performance of a full-scale dryer.
- Incorporated exhaust and fan system.
- Exhaust oil drip tray.
- High-pressure airflow to achieve optimal curing penetration.
- Slide-out air filter for easy maintenance.



The Digibox Hot Air conveyor dryer provides all the curing advantages expected from any Adelco Textile dryer product with features only found on higher priced models. Power efficiency is a key feature of the Digibox and enables customers to minimise or reduce their Carbon Footprint

Specifications

Specs	DG80E-1
Electrical supply	3 P 220-240V or 380V-415V, 50/60hz
Maximum electrical consumption	10 Kw/h
Average electrical consumption at 160°C	5 Kw/h
Belt speed	30 seconds - 12 minutes
Time required to reach 160°C	20 minutes
Exhaust diameter	10cm
Belt width	80cm
Infeed/Outfeed	40cm
Oven length	100cm
Overall dimentions	180cm x 110cm x 116cm

Model	1 Minute	2 Minutes	3 Minutes
DG80E-1	120 pcs/hour	60 pcs/hour	40 pcs/hour
DG80E-2	240 pcs/hour	120 pcs/hour	80 pcs/hour
DG80E-3	360 pcs/hour	180 pcs/hour	120 pcs/hour
DG80E-4	480 pcs/hour	240 pcs/hour	160 pcs/hour

Based on one product placed on belt every 50cm. Production rates may vary depending on the placement of products and the chosen time/temperature settings tailored to meet specific curing demands.

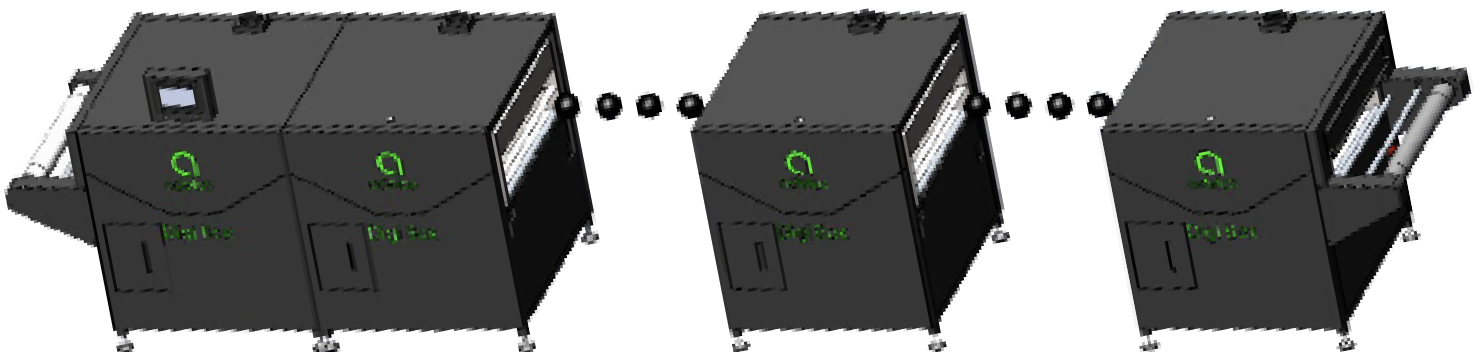

DIMENSIONS

∅ 100

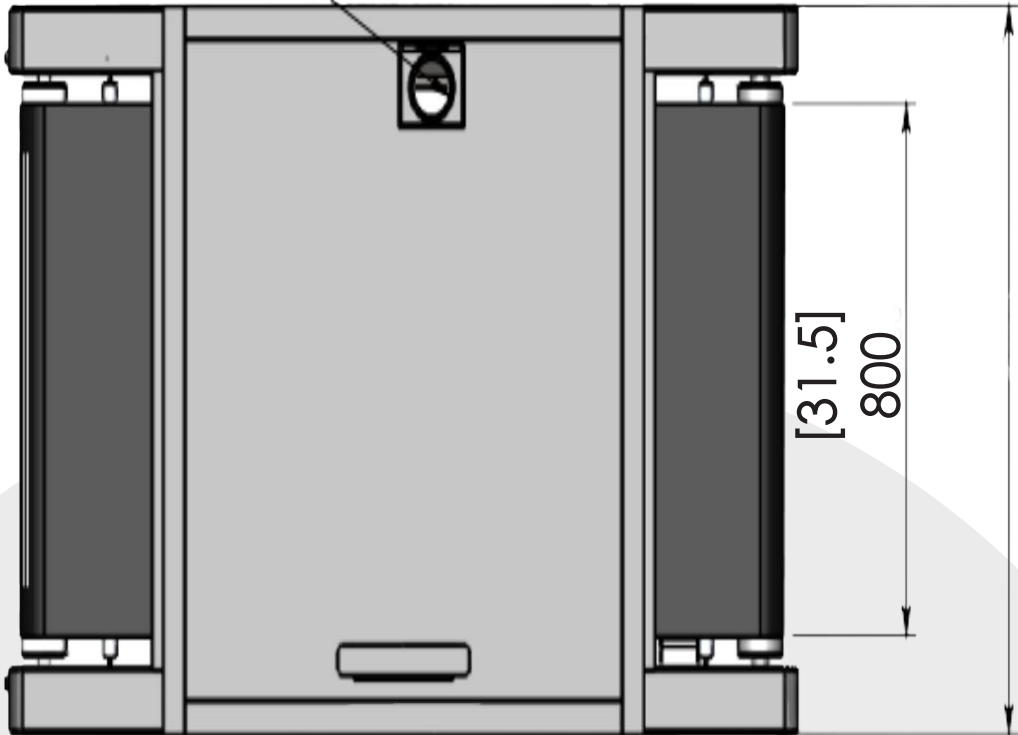

[70.87]
1800

[15.75]
400

[15.75]
400



Digi Box

[34.37]
873

[34.37]
873

[45.91]
1166

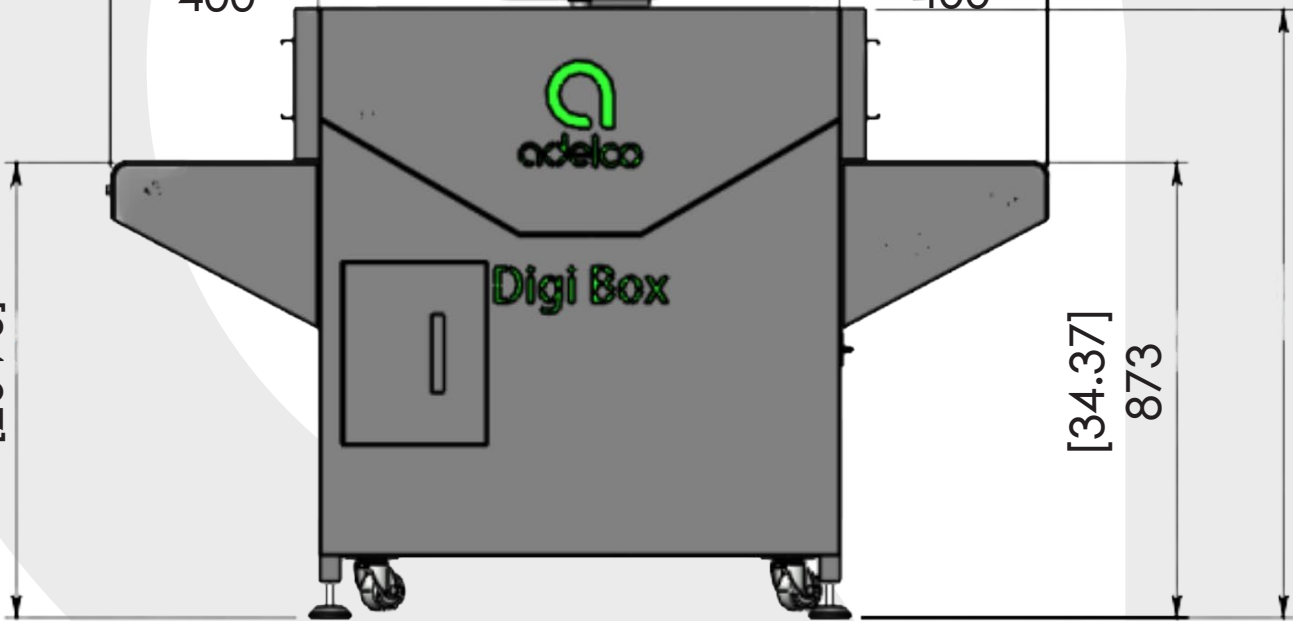

adelco DRAWER DRYING CABINETS

A compact, space-saving and economical solution for the curing of digital and screen printed textile inks.

Automatic Drawer Dryers

Each cabinet incorporates motor driven drawers, operated & controlled by its own cycle timer. Drawers automatically eject for unloading & reloading after the cycle time has counted down. Each drawer is independently controlled via a membrane touch control panel and automatically opens and closes from pre-programmed timers. A digital display counts down the preset times of each independent drawer and shows the time remaining.



DDC-3A



Easy access cleaning - no replacement filters required

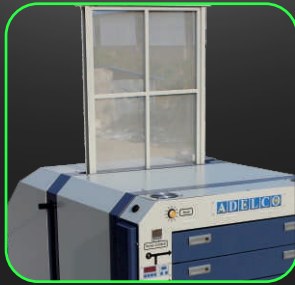

Easy access cleaning - no replacement filters required



DDC-6A

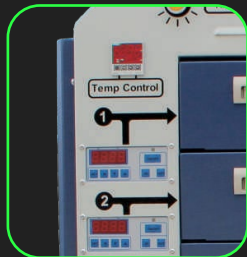

Independent drawer controls



Variable Exhaust

Manual Drawer Dryers

Manually operated draws each with independent timers that give an audible & visual alarm when preset draw times are complete. These units offer a great entry level, low cost solution.



DDC-3M



DDC-6M

Standard Features of All Cabinets

- Digital Temperature Control
- Independent Drawer Timers
- Direct Heated High Velocity Air-Flow
- Permanent Lint Filter (No Replacement Filters Required)
- Variable Exhaust Control
- Hot Air Recirculation
- Easy Load Drawers

Using digitally temperature controlled high velocity air-flow for optimum curing, the DDC balanced air-flow system provides high velocity hot air, directed onto the textile ensuring no loss of heat to the surrounding working area. An efficient and balanced exhaust system ensures removal of all ink and pre-treatment residues in the curing of all digital and screen textile inks.

Three Drawers

The Adelco 3-Drawer drying cabinet offers a compact textile drying solution where DTG printers can be mounted on top of the machine to save even more floor space. Thanks to the drying cabinet's triple insulated exterior and ability to recycle heat for a cool outer skin, there's no residual heat to affect the mounted digital printer, offering the most compact printing and drying solution on the market.

Six Drawers

For increased production requirements, the Adelco Drawer Drying Cabinet also comes available in a six-drawer option. It's ergonomically designed for ease of loading the drawers and each drawer has its own independent digital drawer timer for precise drying times. It has a unique built-in lint filter that can be easily raised above the dryer by a single person, ensuring no further space is required around the dryer and no need for replacement filters.



DDC-3 & DDC-6 Specifications

Description	DDC-3A	DDC-3M	DDC-6A	DDC-6A
Drawer operation	Auto	Manual	Auto	Manual
Electrical Requirements	3Phase, 50/60HZ, 200/220V & 380/415V, 13KW Single Phase option available with optional inverter	3Phase, 50/60HZ, 200/220V & 380/415V, 13KW Single Phase option available with optional inverter	3Phase, 50/60HZ, 200/220V & 380/415V, 19KW	3Phase, 50/60HZ, 200/220V & 380/415V, 19KW
Dimensions	151cm(L) x143cm(W) x79cm(H)	158cm(L) x110cm(W) x81cm(H)	153cm(L) x120cm(W) x134cm(H)	158cm(L) x112cm(W) x133cm(H)

DDC-3 & DDC-6 Production (Per Hour)

Description	DDC-3A		DDC-3M		DDC-6A		DDC-6A	
Kornit Digital Inks Based on 160 degrees celcius, 3 mins for light shirts and 6.05 mins for dark shirts. Note - Increased pre-treatment levels will require longer curing times	60 Light	27 Dark	60 Light	27 Dark	120 Light	54 Dark	120 Light	54 Dark
Epson/Brother/Anajet/Polyprint /Dupont Inks at 2 mins	90 Light	90 Dark	90 Light	90 Dark	180 Light	180 Dark	180 Light	180 Dark

Manual drawer versions are available for a more cost conscious solution, however the automatic drawer models are most popular as they enable the operator to concentrate on the print workflow whilst the curing cycle takes care of itself, automatically.



DDC-6A

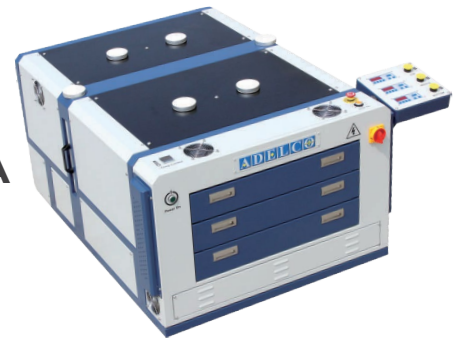

DDC-3A



DDC-6M



DDC-3M

DDC-3 Dimensions

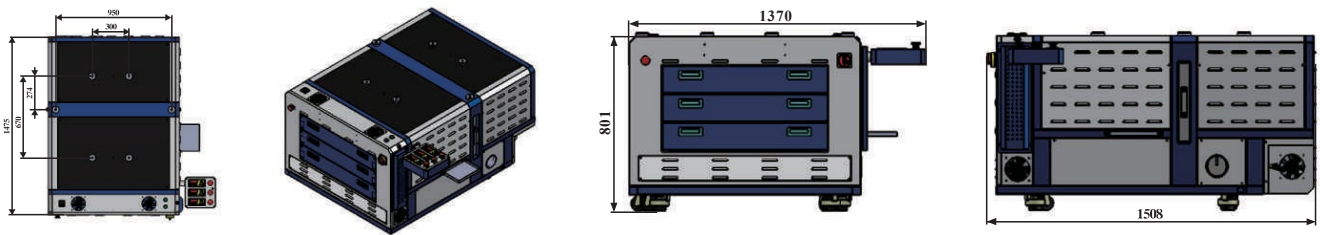

DDC-6 Dimensions

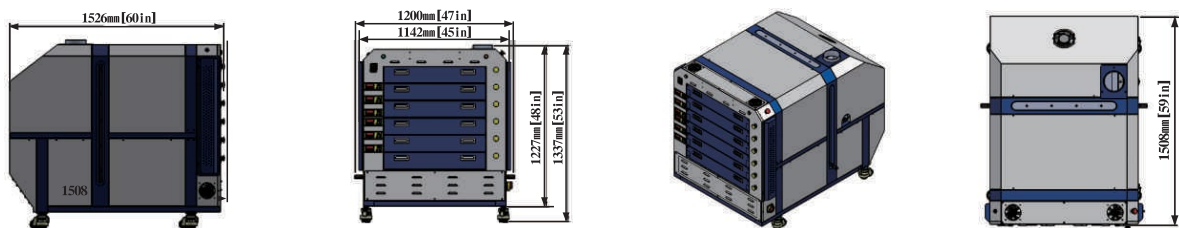

“Adelco dryers have improved the quality of our prints, due to the dryers versatility. The service and technical support that I have received from Adelco over the years have been excellent. Always helpful and available on the phone or on the rare occasion the dryer has needed a service. Our dryer is pretty faultless, other than general wear and tear. I would recommend Adelco and definitely would buy from them in the future.

- Liam Stewart, Vortex Clothing Company Ltd, UK



adelco

ROLL TO ROLL DRYER

The Most Advanced direct to Fabric Drying solution

The **Adelco Roll to Roll dryer** is a sophisticated, triple pass textile dryer featuring **Siemens PLC** and **Honeywell** flame control systems, ensuring maximum efficiency and cost-efficiency. This **proven triple pass R2R** drying system enables three times the production compared to its oven length.

Adelco Roll to Roll conveyor dryer is compatible with both **digital and conventional textile ink systems**. Its modular design allows **seamless expansion**, making it the ideal choice to integrate additional ovens as your business flourishes.



Key Features

- Gas or Electric models
- Modular design allowing customizable sizes
- Three insulating layers ensures a cooler exterior skin
- Easy removable outer panels for rapid internal cleaning
- Easy to clean double air filter



Additional Features

- The discharge port includes a winding device for even fabric rewind.
- High-precision, ergonomic touch screen controls.
- Conveyor belt speed and temperature are adjustable
- Exhaust equipped with oil drip tray
- High-speed heat circulation ensures optimal drying while saving 30% of energy

Capacity

Time	R2R-200E-3B-2	R2R-200E-3B-4	R2R-200E-3B-6
1 minute	480 meters/hour	960 meters/hour	1440 meters/hour
1.5 minute	320 meters/hour	640meters/hour	960 meters/hour
2 minute	240 meters/hour	480 meters/hour	720 meters/hour
2.5 minute	192 meters/hour	384 meters/hour	576 meters/hour
3 minute	160 meters/hour	320 meters/hour	480 meters/hour

Specifications for electric models

Spec	R2R-200E-3B-2	R2R-200E-3B-4	R2R-200E-3B-6
Maximum power consumption	60Kw/h	118Kw/h	176Kw/h
Average power consumption at 150C	36Kw/h	70Kw/h	105Kw/h
Heating Elements	18x3Kw (54Kw)	36x3Kw (108Kw)	54x3Kw (162Kw)
Exhaust diameter	300mm	300mm	300mm

Specifications for gas models

Spec	R2R-200E-3B-2	R2R-200E-3B-4	R2R-200E-3B-6
Intake pressure	4Kpa	4Kpa	4Kpa
Average gas consumption at 150°C (Propane)	3.1 kg/h	5.4 kg/h	9.2 Kg/h
Average gas consumption at 150°C (Natural)	4.1 m ³ /hr	7 m ³ /hr	12 m ³ /hr
Exhaust diameter	300mm	300mm	300mm

Dimensions (2 meter model)

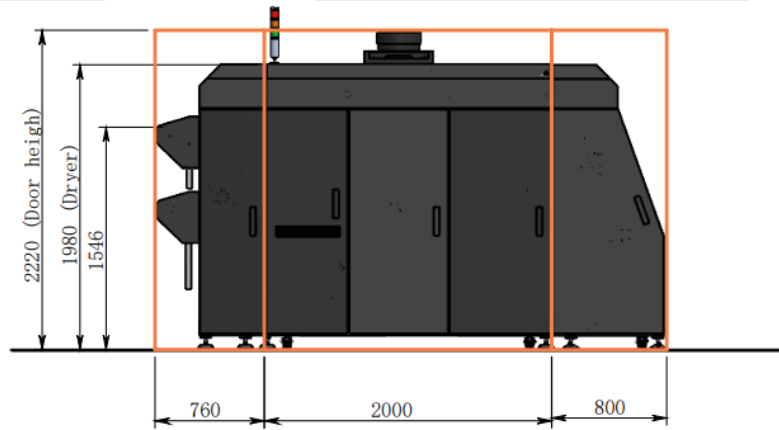
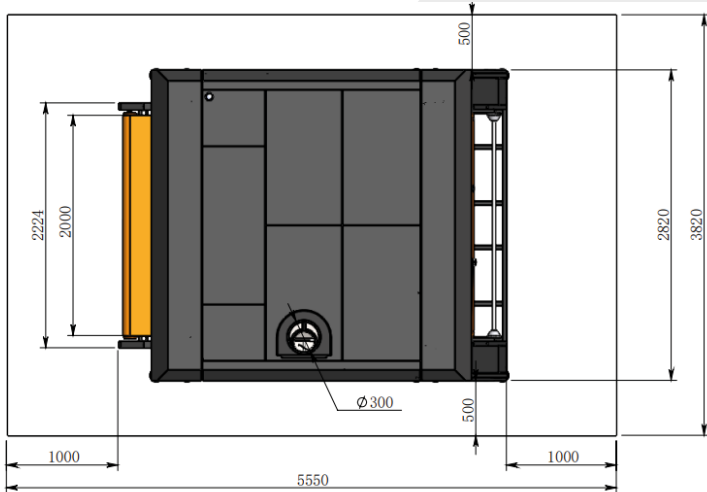

Expandable models

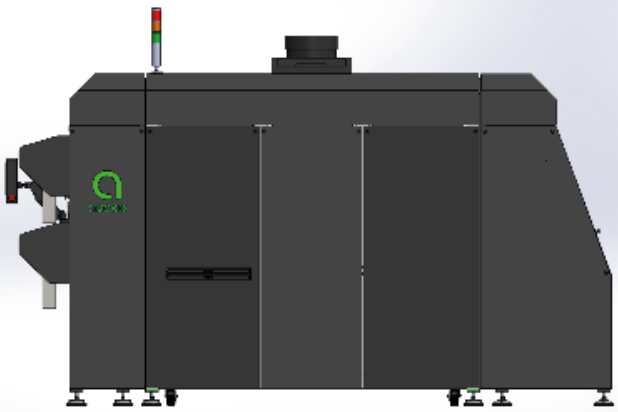

R2R-200E-3B-2



R2R-200E-3B-4



R2R-200E-3B-6

adelco CYCLONE

The **automatic carousel screen printing press** that offers **incredible value for money, with pinpoint precision. Available in three standard print sizes.**

AC servo motors drive the print head for high torque fast smooth print strokes even at the slowest speed.

Pin Point registration of $<+ 0.02\text{mm}$, designed for the most challenging screen and digital printing.

Optional built in LED lights integrated into the print heads provide unmatched visibility of screens during set up and production.

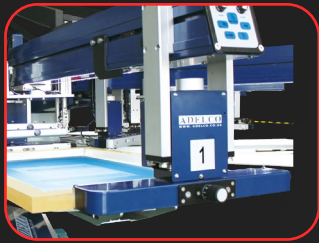

Three-way front and rear micro screen adjustment for easy set up.

Standard high-grade lightweight aluminium pallets with unique tool free quick release system and CNC print arms with unmatched pallet level tolerances.



PLC controlled with HD touchscreen incorporating advanced features, simple set up and full machine self-diagnosis.

Auto start, stop, sample and rotate flash programmes.

Strong and light custom extruded aluminium print heads and pallet arms gives the perfect strength to weight ratio.

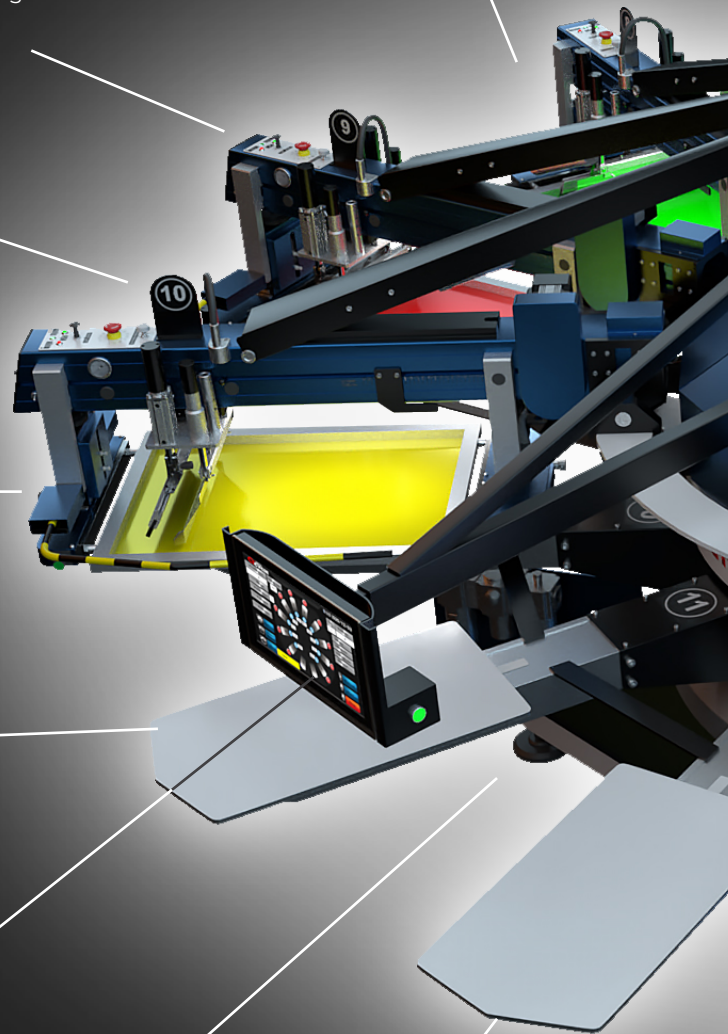

The Adelco Cyclone is an automatic carousel textile screen printing press that offers high-speed printing. The Cyclone is based upon robust, heavy-duty foundations with bespoke lightweight aluminium extrusions and precision CNC parts are fitted with meticulous attention to detail. With its advanced control system, the Cyclone runs pinpoint accuracy at extreme speeds while still offering incredible value for money.

Using the latest advanced technology in textile screen printing, the Cyclone is designed for the most challenging screen printing, with pinpoint registration of $\pm 0.2\text{mm}$. Optional built in LED lights integrate into the print heads to provide unmatched visibility of the screens during set-up and production. The Cyclone uses a rapid lock auto high-lift screen system that provides easy screen cleaning access and loading of flashes into any print head position.

Servo driven main drive gives a fast, smooth index providing speeds in excess of 1000 pieces per hour.

Individual horizontal screen lift at each print head – provides maximum ink stability, better screen visibility and faster loading times as pallets remain at a constant height.

Rapid lock high-lift screen system provides easy screen cleaning access and loading of flashes into any print head position.

Load delay foot pedal

Twin chopper squeegee pressure cylinders provide tool free control of print pressures even with the most viscous ink systems.

Quick lock, tool free squeegees with angle adjustment and flood bars.

The Adelco Cyclone is available in three sizes - small, medium and large. Each comes with different options for the number of colours and print stations so that you can select the best model for your production requirements.

With its servo driven main drive, the Cyclone screen press gives a fast, smooth index that provides print speeds in excess of 1,000 pieces per hour. Even when operating at the lowest speeds, print quality is uncompromised thanks to its AC servo-motors that drive the print head for smooth print strokes. It also comes with strong and light custom extruded aluminium print heads and pallet arms, providing the perfect strength to weight ratio.

Carousel - S Models

Model	No of Colours	No of Stations	Max Print Area	Max Screen Size	Diameter	Standard Pallet Size	Standard Sq/FI Size	Air Supply 8bar (115psi)	Electrical Supply
CYA-6/8-4550	6	8	45x50cm (18"x20")	58.5x78.8cm (23"x31")	343cm (135")	47x72cmm (18.5"x28")	47cm	23.6m ³ /h (13.9cfm)	1P220V/6.8KW
CYA-8/10-4550	8	10	45x50cm (18"x20")	58.5x78.8cm (23"x31")	389cm (153")	47x72cmm (18.5"x28")	47cm	31m ³ /h (18.3cfm)	1P220V/8.3KW
CYA-10/12-4550	10	12	45x50cm (18"x20")	58.5x78.8cm (23"x31")	430cm (169")	47x72cmm (18.5"x28")	47cm	38.6m ³ /h (22.72cfm)	1P220V/9.8KW
CYA-12/14-4550	12	14	45x50cm (18"x20")	58.5x78.8cm (23"x31")	472cm (186")	47x72cmm (18.5"x28")	47cm	46m ³ /h (27.1cfm)	1P220V/11.3KW
CYA-14/16-4550	14	16	45x50cm (18"x20")	58.5x78.8cm (23"x31")	513cm (202")	47x72cmm (18.5"x28")	47cm	53.5m ³ /h (31.5cfm)	1P220V/12.8KW

Carousel - M Models

Model	No of Colours	No of Stations	Max Print Area	Max Screen Size	Diameter	Standard Pallet Size	Standard Sq/FI Size	Air Supply 8bar (115psi)	Electrical Supply
CYA-8/10-5070	8	10	50x70cm (20"x28")	63.5x99.2cm (25"x39")	446cm (175")	52x92cmm (20"x36")	52cm	31m ³ /h (18.3cfm)	1P220V/8.3KW
CYA-10/12-5070	10	12	50x70cm (20"x28")	63.5x99.2cm (25"x39")	490cm (193")	52x92cmm (20"x36")	52cm	38.6m ³ /h (22.72cfm)	1P220V/9.8KW
CYA-12/14-5070	12	14	50x70cm (20"x28")	63.5x99.2cm (25"x39")	535cm (210")	52x92cmm (20"x36")	52cm	46m ³ /h (27.1cfm)	1P220V/11.3KW
CYA-14/16-5070	14	16	50x70cm (20"x28")	63.5x99.2cm (25"x39")	579cm (228")	52x92cmm (20"x36")	52cm	53.5m ³ /h (31.5cfm)	1P220V/12.8KW

Carousel - L Models

Model	No of Colours	No of Stations	Max Print Area	Max Screen Size	Diameter	Standard Pallet Size	Standard Sq/FI Size	Air Supply 8bar (115psi)	Electrical Supply
CYA-8/10-6080	8	10	60x80cm (23.5"x31.5")	74x109cm (29"x43")	498cm (196")	62x102cmm (24"x40")	62cm	31m ³ /h (18.3cfm)	1P220V/8.3KW
CYA-10/12-6080	10	12	60x80cm (23.5"x31.5")	74x109cm (29"x43")	550cm (217")	62x102cmm (24"x40")	62cm	38.6m ³ /h (22.72cfm)	1P220V/9.8KW
CYA-12/14-6080	12	14	60x80cm (23.5"x31.5")	74x109cm (29"x43")	601cm (237")	62x102cmm (24"x40")	62cm	46m ³ /h (27.1cfm)	1P220V/11.3KW
CYA-14/16-6080	14	16	60x80cm (23.5"x31.5")	74x109cm (29"x43")	652cm (257")	62x102cmm (24"x40")	62cm	53.5m ³ /h (31.5cfm)	1P220V/12.8KW

Easily position
Flash Cures into
any print head



“My experience with Adelco has been fantastic and I would recommend Adelco and their products to anyone. I have known Mark a long time and would consider him a friend more than just a business contact. He is someone we can trust, honest to his word, and if he says he is going to do something he does.

- Jon Lunt, T Shirt & Sons. UK

adelco MATRIX

A modular oval screen printer that provides more versatility and high-production output.

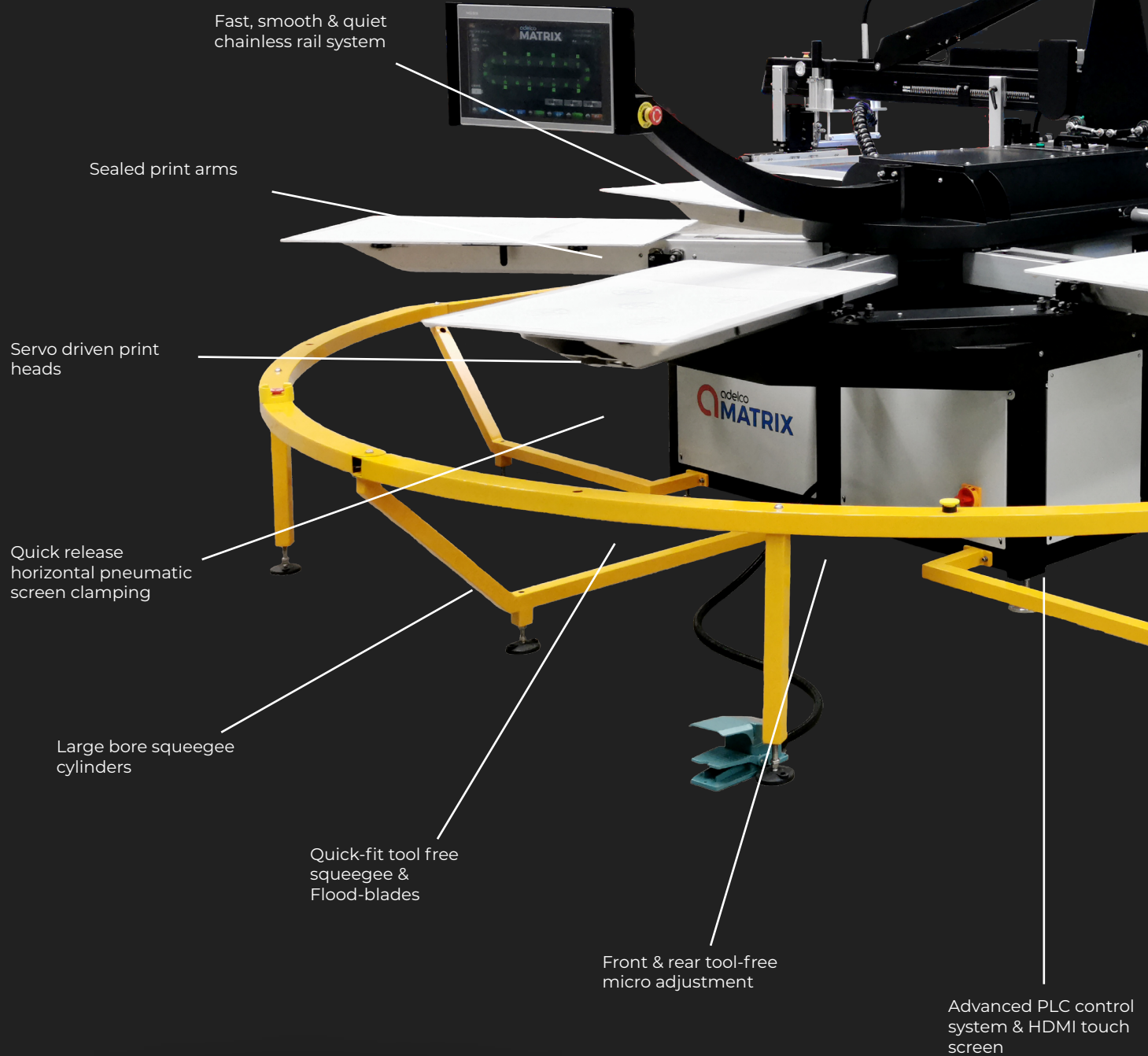



Safe, Modular, Expandable.

The Matrix Oval screen printing machine from Adelco offers a more efficient use of space thanks to its oval-shaped design. It offers greater stability with larger print formats than comparable carousel based machines. The Matrix Oval provides more versatility with multiple flashes, cooling and speciality print stations, providing the highest print quality and accuracy.

Available in three standard print size formats, the Matrix can be configured for almost any production requirement with an infinite number of pallets and print stations. Its servo driven print heads enable cycle times in excess of 900 prints per hour.

It has a unique rail and drive system that ensures almost silent operation, creating a quiet print-shop environment.

Pallets are securely locked with hardened locators. Indexing to an accuracy of +/- 0.02mm.

Safety barriers, proximity sensors, and safety lasers run the full length of the machine that immediately stops the machine if activated. The Matrix Oval is designed with safety as a priority, with worldwide renowned certification.

The Matrix Oval offers unparalleled support of print heads & pallet arms during print cycle for exceptional print quality and repeatability.

Electrical Requirements	
<28 stations	>28 stations
1 phase 220V 2KW + 750W per print head	1 phase 220V 4KW + 750W per print head

Air Supply	
Pressure	CFM (per print head)
100PSI/7bar	3 CFM

Standard Image Area	Max Frame Size	Max Machine Width	Length
45x60cm (18"x24")	64x100cm (27"x43")	363cm (143")	Depends on format
50x70(20"x28")	69x110cm (27"x43")	398cm (157")	Depends on format
60x80cm (23.5"x31.5")	79x120cm (31"x47")	418cm (165")	Depends on format

Print-Flash-Cool Format

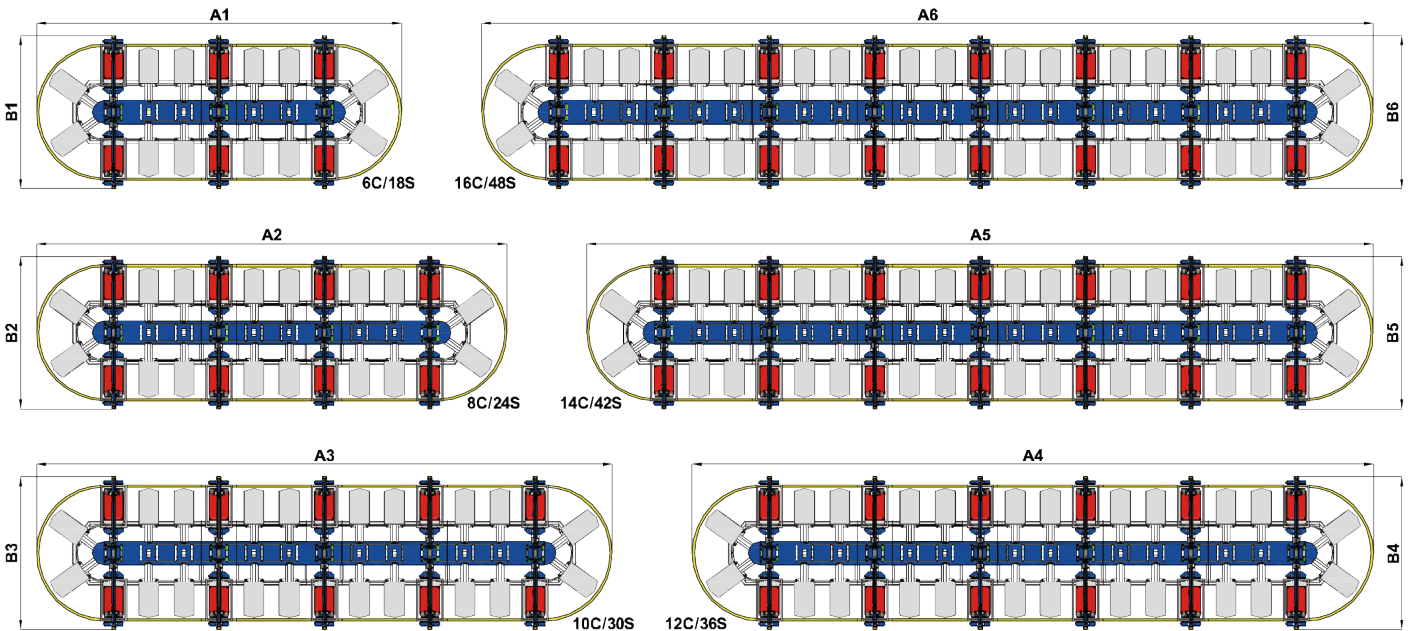

Model	6C/18S		8C/24S		10C/30S		12C/36S		14C/42S		16C/48S	
	A1	B1	A2	B2	A3	B3	A4	B4	A5	B5	A6	B6
MTX 4560	8.68M	3.63M	11.12M	3.63M	13.55M	3.63M	15.99M	3.63M	18.45M	3.63M	20.87M	3.63M
MTX 5070	9.48M	3.98M	12.23M	3.98M	14.97M	3.98M	17.71M	3.98M	20.45M	3.98M	23.19M	3.98M
MTX 6080	9.68M	4.18M	12.43M	4.18M	15.17M	4.18M	17.91M	4.18M	20.65M	4.18M	23.39M	4.18M

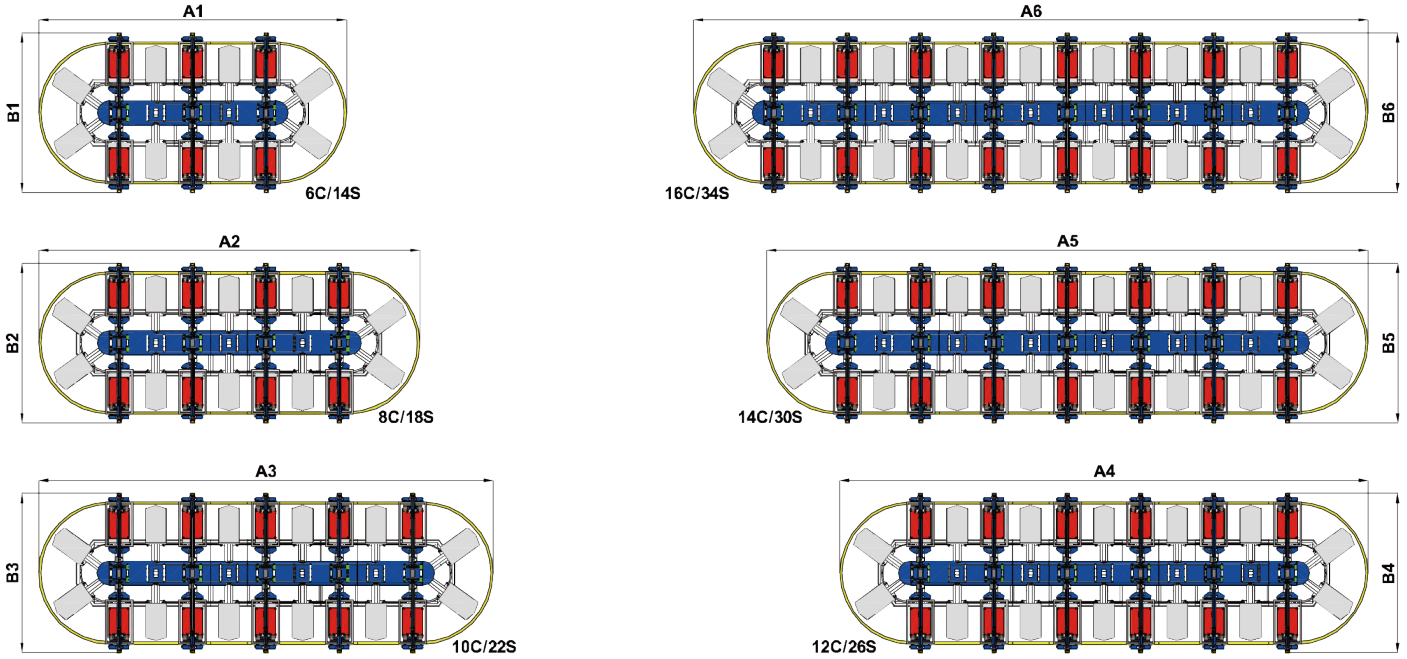

Model	6C/14S		8C/18S		10C/22S		12C/26S		14C/30S		16C/34S	
	A1	B1	A2	B2	A3	B3	A4	B4	A5	B5	A6	B6
MTX 4560	7.05M	3.63M	8.68M	3.63M	10.30M	3.63M	11.93M	3.63M	13.55M	3.63M	15.18M	3.63M
MTX 5070	7.66M	3.98M	9.48M	3.98M	11.31M	3.98M	13.14M	3.98M	14.97M	3.98M	16.80M	3.98M
MTX 6080	7.86M	4.18M	9.68M	4.18M	11.51M	4.18M	13.34M	4.18M	15.17M	4.18M	17.00M	4.18M

“In our line of work - **quality, consistency** and **speed** are of utmost importance and Adelco delivered all that! Customer service is **excellent** and the machine is everything I had expected it would be. Our production levels are **way up** and because of that, it helped my business grow.”

- Carter Lee, VSC Textile Printing, Philippines

adelco ELLIPSE

Unique in the market place having **front and rear registration locators** and **pallet support** providing the **most stable and accurate registration** on extra large print areas

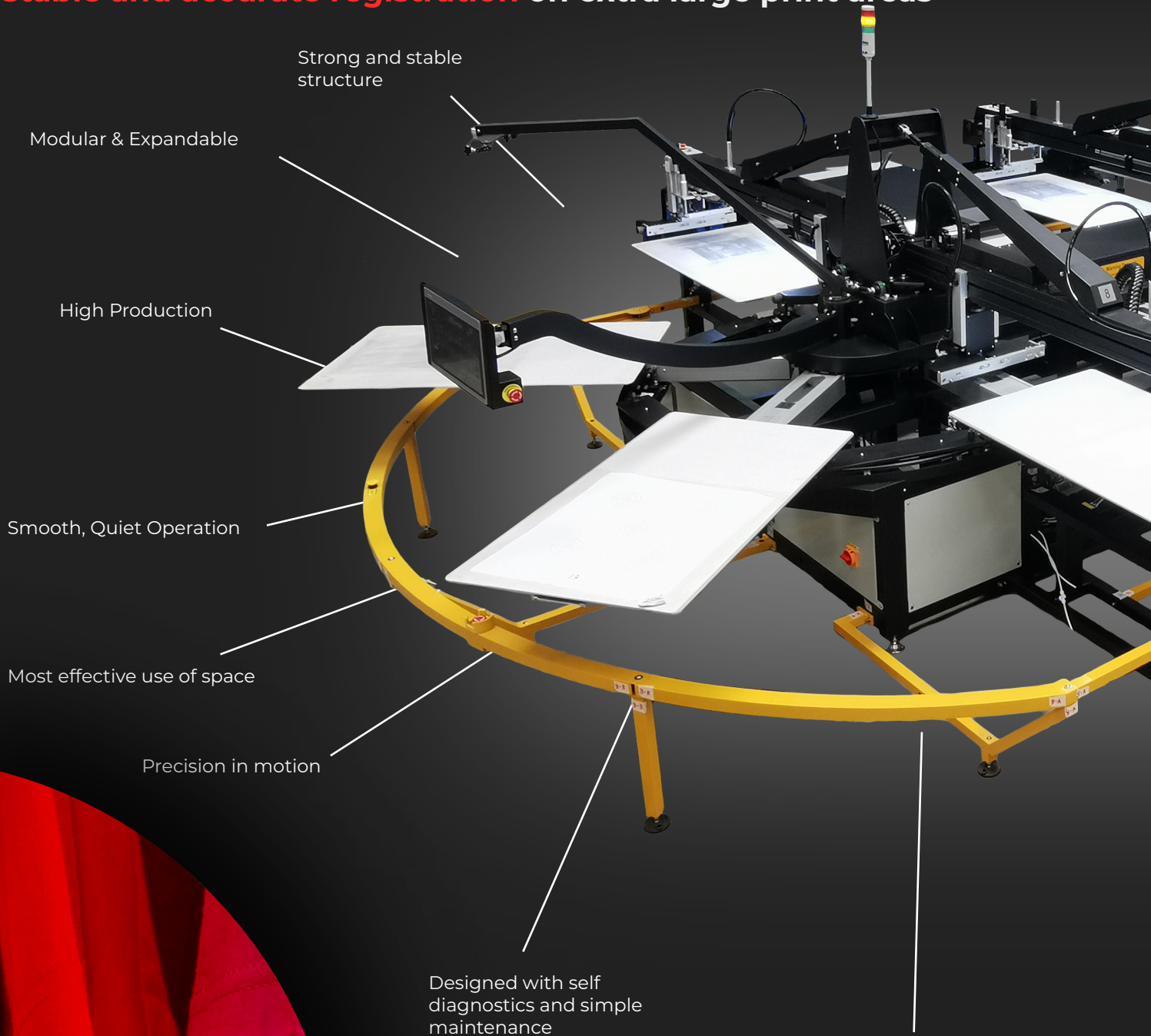

- Optional extras including:
- Digital docking station
 - Humidifier
 - Flocking
 - Hot Iron

The Adelco Ellipse Oval can be configured for almost any screen-printing production requirement with an infinite number of stations and print heads. With its' modular make-up, this screen printer can be easily scaled up as your business and print requirements grow. The best solution for print areas of 70x100cm and above with a high power servo index, allowing for cycle times of 700 or more prints per hour.

Precision printing is achieved using the Ellipse Oval, as pallets are locked front and back, offering accuracy of +/- 0.02mm. The Ellipse Oval also features a unique floating pallet design, which is chainless for extreme longevity and smooth pallet index.

The Ellipse Oval features an advanced PLC control system with human interface for all operator functions including auto start and auto finish.



The Ellipse Oval is designed by British engineers and built at our state of the art manufacturing facility located near Shanghai. The Ellipse Oval has superior build quality, heavy duty construction with front and rear support for both print head and pallet arms to deliver exceptional print quality.

The servo driven printheads deliver exceptional speed and control torque, and feature adjustable screen chase, three-way responsive micro registration, quick release squeegee/flood blades, front and rear off contact and levelling adjustment, and a quick release high lift facility for rapid screen cleaning or flash cure docking.

Every printer head is fitted with a touch panel control for all main printing functions. Rigid pallet arms optimising servo index, supported front and back during the print cycle provide zero pallet deflection, while at Adelco we also offer a wide range of easily removable pallet style and sizes.

Features

- Chainless pallet drive system for extreme longevity and smooth pallet index.
- Guaranteed lifetime registration. Our unique lock system which is located on every pallet arm, disengages the pallet from the drive mechanism ensuring consistent pin-point lifetime registration.
- Servo driven printheads delivering exceptional speed and control torque, even at lower speeds our printheads feature adjustable screen chase, three-way responsive micro-registration, quick release squeegee/flood blades, front and rear off-contact and levelling adjustment, a quick release high lift facility for rapid screen cleaning or flash cure docking. Every head is fitted with a touch panel control for all main printing functions.
- Rigid pallet arms optimizing servo index, supported front and back during the print cycle providing zero pallet deflection. We offer a wide range of easily removable pallet styles and sizes.
- Superior build quality, heavy duty construction for both print head and pallet arms delivering exceptional print quality.
- 2 year limited warranty – The Ellipse Oval is covered by a 2 limited year warranty and supported by our global network of service agents and distributors

Electrical Requirements	
<28 stations	>28 stations
1 phase 220V 1.5KW + 700W per print head	1 phase 220V 2.5KW + 700W per print head

Air Supply	
Pressure	CFM (per print head)
100PSI/7bar	3 CFM

Standard Image Area	Max Frame Size	Max Machine Width	Length
70x100cm (28"x39")	89x140cm (35"x55")	440cm (173")	Depends on format
80x120cm (31.5"x47.2")	99x160cm (39"x63")	480cm (189")	Depends on format

Larger print sizes quoted on request

Print-Flash Format

Model	6C/14S		8C/18S		10C/22S		12C/26S		14C/30S		16C/34S	
	A1	B1	A2	B2	A3	B3	A4	B4	A5	B5	A6	B6
OVAL70100	8.92M	4.4M	11.05M	4.4M	13.18M	4.4M	15.32M	4.4M	17.45M	4.4M	19.59M	4.4M
OVAL80120	10.01M	4.8M	12.29M	4.8M	14.58M	4.8M	16.87M	4.8M	19.15M	4.8M	21.44M	4.8M

Larger print sizes quoted on request

Print-Flash-Cool Format

Model	6C/20S		8C/26S		10C/32S		12C/38S		14C/44S		16C/50S	
	A1	B1	A2	B2	A3	B3	A4	B4	A5	B5	A6	B6
OVAL70100	11.05M	4.4M	14.25M	4.4M	17.45M	4.4M	20.65M	4.4M	23.85M	4.4M	27.06M	4.4M
OVAL80120	12.09M	4.8M	15.75M	4.8M	19.15M	4.8M	22.58M	5.35M	26.01M	5.35M	29.44M	5.35M

Larger print sizes quoted on request



Model No: OPP-8C36S-80120
8 colour - 36 Station
80x120cm Printing Area

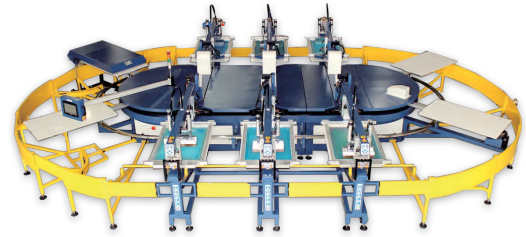

Model No: OPP-6C10S-70100
6 colour - 10 Station
70x100cm Printing Area



Bespoke oval design auto
sock printer illustrated

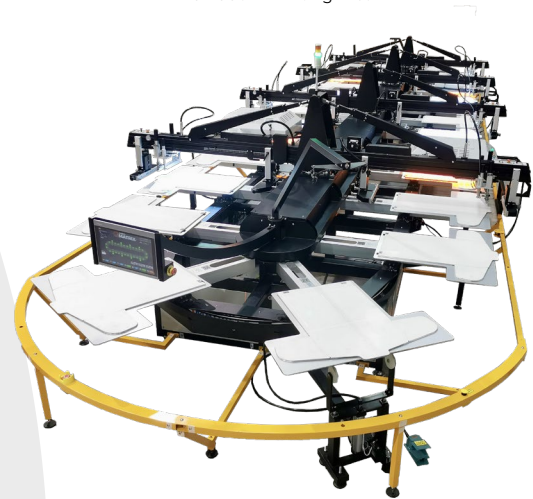

All Over Oval Printing Press
Prints on every part of the
shirt.

“I would recommend any of the Adelco products to anyone, not only for the quality, but definitely for the support offered after the sale.”

- Rob Dubow, Dubow Textile Inc. USA

“In our line of work - **quality, consistency** and **speed** are of utmost importance and Adelco delivered all that!

Customer service is **excellent** and the machine is everything I had expected it would be.

Our production levels are **way up** and because of that, it helped my business grow.”

- Carter Lee, VSC Textile Printing, Philippines

adelco AD HYBRID DIGITAL

A high-speed **digital textile printer** that works seamlessly **with our automatic screen printing presses** with the lowest ink cost per print.

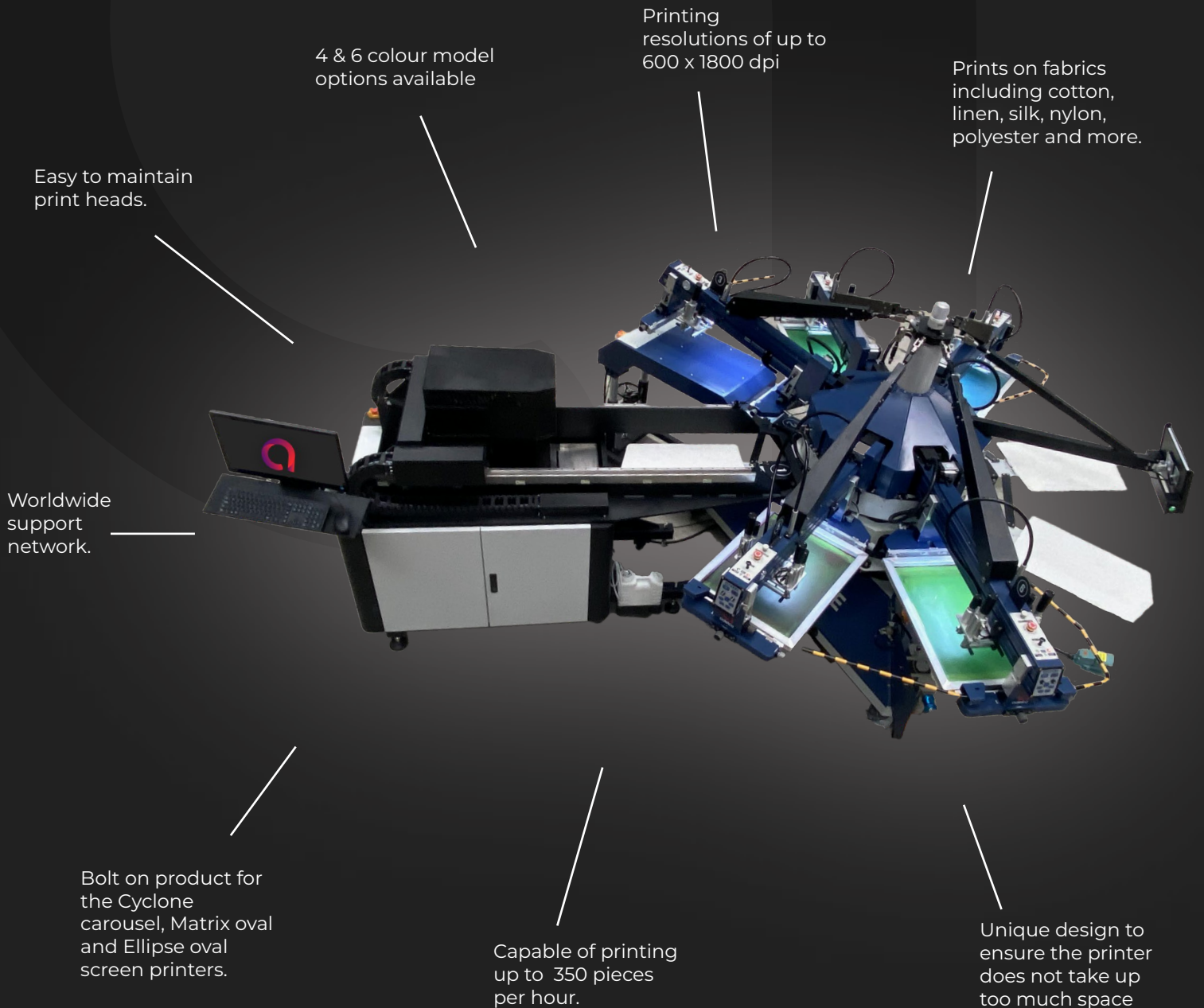

4 & 6 colour model options available

Printing resolutions of up to 600 x 1800 dpi

Prints on fabrics including cotton, linen, silk, nylon, polyester and more.

Easy to maintain print heads.

Worldwide support network.

Bolt on product for the Cyclone carousel, Matrix oval and Ellipse oval screen printers.

Capable of printing up to 350 pieces per hour.

Unique design to ensure the printer does not take up too much space

A digital add-on for the Cyclone, Matrix and Ellipse.



Adelco's Hybrid Digital system is an add-on High Speed Digital Station designed to work in conjunction with the Adelco Automatic Screen Printing Presses, the Cyclone carousel, Matrix Oval and Ellipse Oval. This Hybrid digital system combines the advantages of both screen and digital printing to create even the most innovative garment decoration.

Utilising environmentally friendly inks, Adelco's AD Hybrid Digital can produce A3 format printed substrates in excess of 350 units per hour, and when used in conjunction with a screen printed base providing the lowest ink cost per print.

Using industrial grade Ricoh print heads for maximum stability, durability and reliability, Adelco's AD Hybrid Digital solution can achieve complex designs. The system is quick to set up and prints quickly without the need for costly separations or screen manufacture.

Combine digital print, spot colour, high build, glitter, puff, flock, foil and other special effect prints all on one print machine. The Adelco AD Hybrid has a built in humidifier and ink recirculation system.

Offering superb accuracy of 0.05kps, and with an ink sensor alarm, auto and manual ink supply the AD Hybrid covers all the bases.

- A3 print up to 350 per hour
- Softest hand feel on the market
- Worldwide support network
- Environmentally friendly inks
- Industrial grade Ricoh print heads



Digital Printer sizes (mm)	400 x 500 - CMYK
	400 x 500 - CMYK, Red and Green
	500 x 700 - CMYK
	500 x 700 - CMYK, Red and Green
	600 x 800 - CMYK
	600 x 800 - CMYK, Red and Green
Printing Resolution	600x1200dpi, 600x1800dpi
Printing Fabric	Cotton, linen, silk, nylon, polyester, viscose, etc.
Max Printing Area	600x800mm
Max Speed	350pcs/h
Ink Type	Pigment Ink
Max Media Thickness	25mm
Ink Supply System	Auto negative pressure ink supply system
Ink Capacity	5L/colour
RIP Software	Caldera
Printhead Maintenance	Self-Cleaning
	Auto Ink Wiping System
	Built in Humidifier
	Built in Ink Recirculation System
Power Supply	220vAC, single phase, 50/60hz
Work Environment	Temperature 25-28°C, Humidity, 55%-65%
Print Heads	400 x 500 4 Colour - 8 x 512 nozzle Ricoh print head modules
	400 x 500 6 Colour - 12 x 512 nozzle Ricoh print head modules
	500 x 700 4 Colour - 10 x 512 nozzle Ricoh print head modules
	500 x 700 6 Colour - 15 x 512 nozzle Ricoh print head modules
	600 x 800 4 Colour - 12 x 512 nozzle Ricoh print head modules
	600 x 800 6 Colour - 18 x 512 nozzle Ricoh print head modules

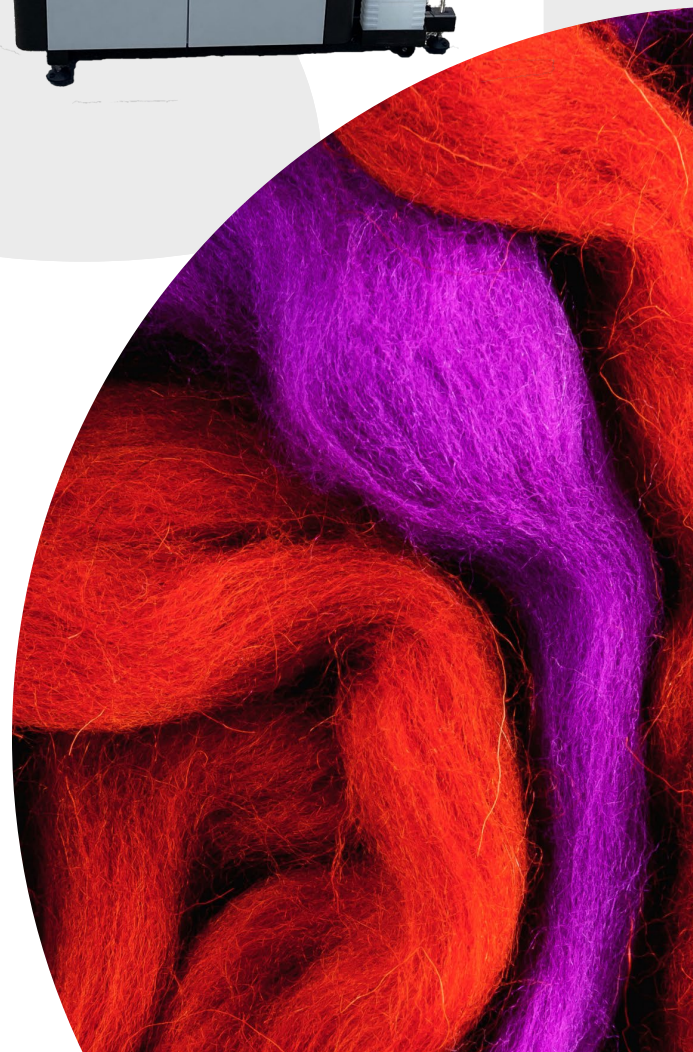



Printer Re-Circulation Powder & Dryer System

Introducing a fully intelligent HD four headed **DTF printer and automatic re-circulation powder system**. The fastest and highest spec printer in the market. The built-in dryer supplements the **DTF** making it the most complete solution in the market.

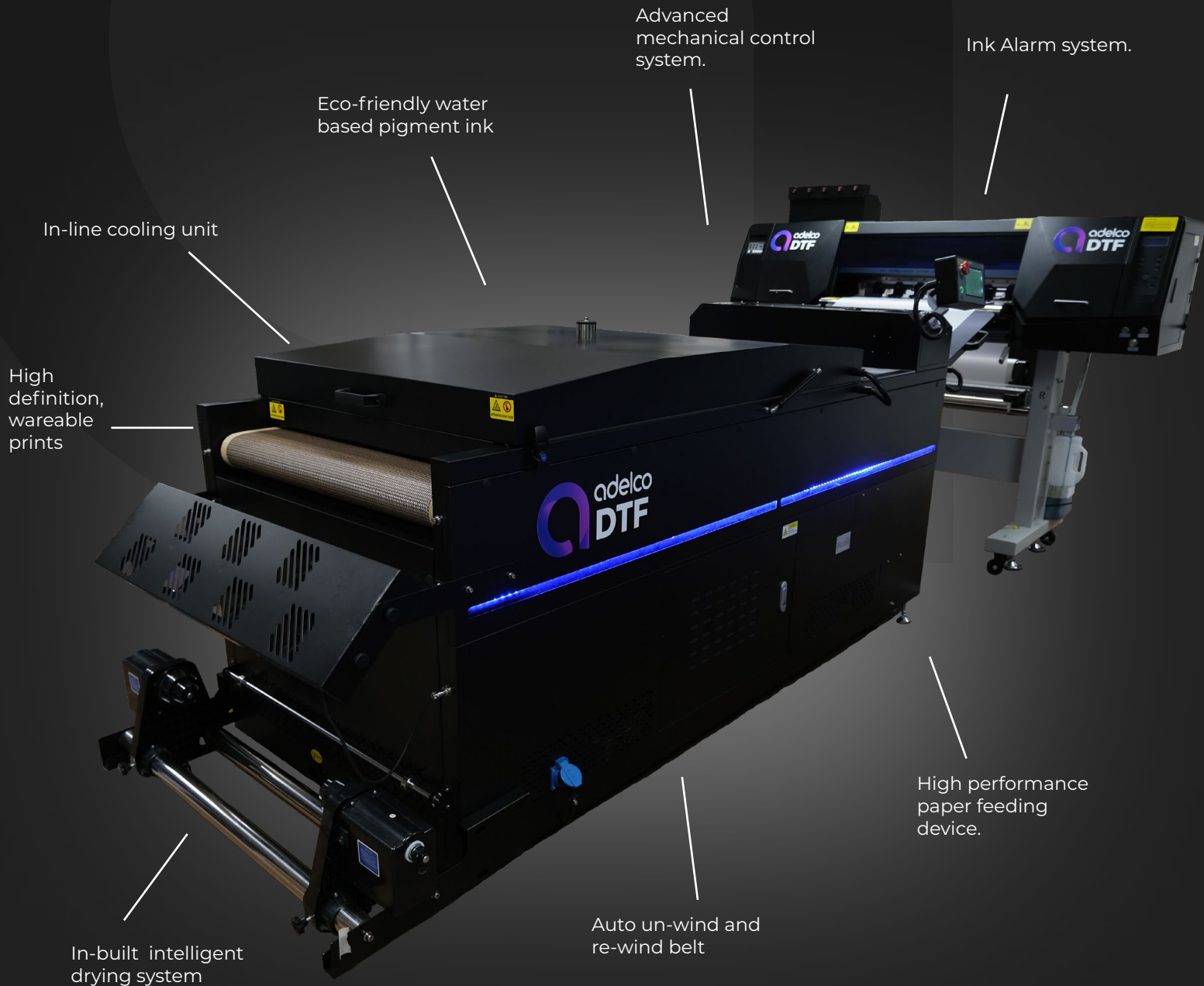

A powerful and efficient DTF system complete with an automatic re-circulation powder and dryer solution



Adelco's Direct to Film printer has a high aluminum milling frame ensuring a stable output with four print heads. This system comes with an advanced mechanical control system that ensures more stable printing. With a thoughtful and easy touch screen operating system the printer is easy to use. Features of the printer includes:

- A precision paper pinch roller - Ensures accuracy and stability of the paper.
- Advanced capping station - Keeps ink flow fluent.
- Intelligent system with suction panels - Simple and responsive.
- Ink alarm system - allows ink to be added in advance, avoiding printing abnormalities caused by ink shortage.
- Anti-collision device of print heads. - avoid collision between print head and trolley.
- Industrial motor drive - High spec, improved printing efficiency.

Adelco's DTF comes complete with automatic re-circulating powder unit, making the process efficient and seamless. Features include:

- Drying system - ensuring immediate drying when printing at speed.
- One meter heating tunnel - Progressive heating with long service life, even and economical heating.
- Built-in cooling unit - Automatically controls and adjusts the temperature.
- Touch screen control system - Intelligent digital control simple and effective.
- High performance paper feeding device. - suitable for a variety of materials.

	4 Head DTF Printer	2 Head DTF Printer
Printing heads	4 x Epson I3200 - A1	2 x Epson I3200 - A1
Print Width	600mm	600mm
Resolution	3200dpi	3200dpi
Colour	CMYK & White	CMYK & White
Ink Type	Pigment Ink	Pigment Ink
Power Supply	220V - 50HZ/60HZ (110V Option) 1500W	220V - 50HZ/60HZ (110V Option) 1400W
Speed	4 pass: 27m ² /h 6 pass: 17m ² /h 8 pass: 13m ² /h	4 pass: 14m ² /h 6 pass: 11m ² /h 8 pass: 8m ² /h
Operation Environment	Temperature 18 - 35°C, Humidity: 40RH - 70RH	Temperature 18 - 35°C, Humidity: 40RH - 70RH
Machine Size	1925 x 800 x 1667mm	1680 x 820 x 1430mm
Package Size	2300 x 760 x 860 mm	2370 x 750 x 650 mm
Weight	216Kg	160Kg
Re-Circulation Powder System	Yes	Yes
Applicable Film Width	600mm	600mm
Applicable Speed	18m ² /h	18m ² /h
Platform Temperature	75°C	75°C
Drying Temperature	110°C	110°C
Media Type	PET transfer film	PET transfer film
Media Transport	Belt guide system and dual powered take-up	Belt guide system and dual powered take-up
Power Supply	220V 50HZ/60HZ 6500W	220V 50HZ/60HZ 5000W
Operation Environment	Temperature 18-30°C Humidity 40Rh-60RH	Temperature 18-30°C Humidity 40Rh-60RH
Heating	Intelligent 10 heating tubes infrared heating	Intelligent 5 heating tubes infrared heating
Machine Size	3122 x 1130 x 1105mm	1920 x 1000 x 1210mm
Package size	2360 x 1150 x 1280 mm	1850 x 1150 x 1280 mm
Weight	297Kg	270Kg

Introducing an intelligent accessory for our **DTF printer**. The **DTF Cutter**, the perfect companion for the **DTF**.

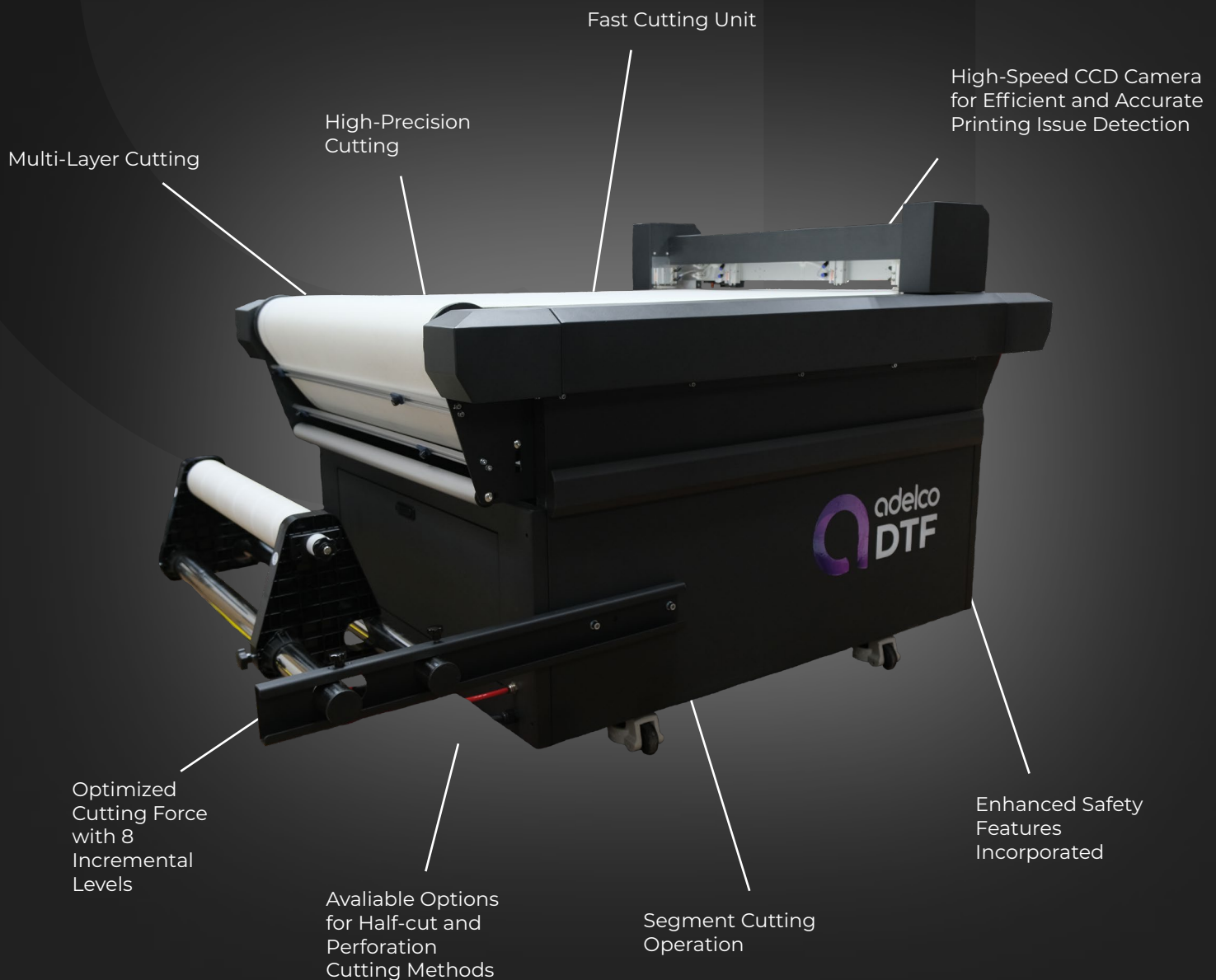

A highly intelligent CNC Digital Cutter unit.

A perfect pair for our DTF solution for a seamless DTF solution



Adelco's computerized numerical control Digital Cutter comes equipped with an advanced high-precision cutting unit that ensures the highest detail in small designs. Paired with a safety motor tool that will pause operations whenever the carriage is jammed.

Features of the cutter includes:

- A fast cutting unit - A variety of speeds for any volume of productions.
- Multi-layer cutting - Capable to cut through multiple layers at one and apply different strengths across the different layers.
- High-speed CCD camera - Extremely efficient in detecting printing issues and accurate recognition of problems.
- High-precision cutting unit - Remarkably accurate, able to do consistent cuts as small as 0.8mm.
- Adjustable cutting levels - 8 different cutting strengths perfect for any job.
- Half-cut & Perf Cut - Versatile for any type of need.
- Adjustment algorithm - Able to detect and discard distorted, rounded or lifted corner designs
- Accurate cutting paths - No longer need to overcut, the start and end nodes line up with each other accurately.
- Segment cutting operation - Capable for a more precise alignment using different types of axis around the designs. Perfect for tracking long rolls, laminated designs and heavier materials.
- Cutting along the dotted lines - Available feature when cutting 2 layers and capable of performing with different types of paper

	DTF Cutter 60cm	DTF Cutter 140cm
Working Size	350 x 450mm or 610 x 900mm	1300 x 1410mm or 1260 x 1410mm
Applicable Media Thickness	0.03 - 1mm	≤1.5mm
Applicable Media	Balanced pliability for soft and rigid materials	Reflective sheeting, PPF, window tint, PPE, PET, Vynil, Paper
Method	Vacuum pump and/or adhesive mat	Conveyor & roll media bracket - Vacuum table
Cutting Speed	600mm/s	600mm/s
Cutting Force	600g / 5.8N in 8th level	600g / 5.8N in 8th level
Cutting Set-up	Adjustable in every 1g	Adjustable in every 1g
Blade Diameters	0.9mm, 1.5mm, 2.0mm	2.0mm
Blade Angles	30°, 45°, 60°	30°, 45°, 60°
Dotted Lines Cutting	Included	Included
Drive	AC Servo	AC Servo
Mechanical Resolution	0.0125mm	0.0125mm
Compatible OS	Win 10/ 8 / 7 / XP	Win 11/10 / 8 / 7
Memory Buffer	2 MB	2 MB
Software	Windows Driver, SignWorkPro, CADtoPlotpro & CADlink	Windows Driver, SignWorkPro, CADtoPlotpro & CAD link
LCD	English	English
File Format	HP-GL, PLT	HP-GL, PLT
Port in Standard	USB, RS-232	USB, RS-232
Registration Marks Recognition	CCD Camera	CCD Camera
Power Input	110 - 220V AC, 50 - 60Hz	110 - 220V AC, 50 - 60Hz
Power Consumption	620w or 900w	3,2kw
Cutter Holder / Pen Holder	1 for each	1 for each
Types of Pen	Water based fiber-tip pen & oil based ball pen	Water based fiber-tip pen & oil based ball pen
Package Size L - W - H	1050 x 760 x 600mm or 1350 x 1220 x 1220mm	1900 x 2200 x 1030mm or 2000 x 2100 x 1270mm
Gross / Net Weight	67 / 52kg or 160 / 90kg	480/320kg

adelco UV DTF

Introducing Adelco's three head **UV DTF printer**. Experience **unmatched versatility** with the most advanced printer on the market. Effortlessly apply designs to both **hard and soft substrates**, all while enjoying **economical print costs**.

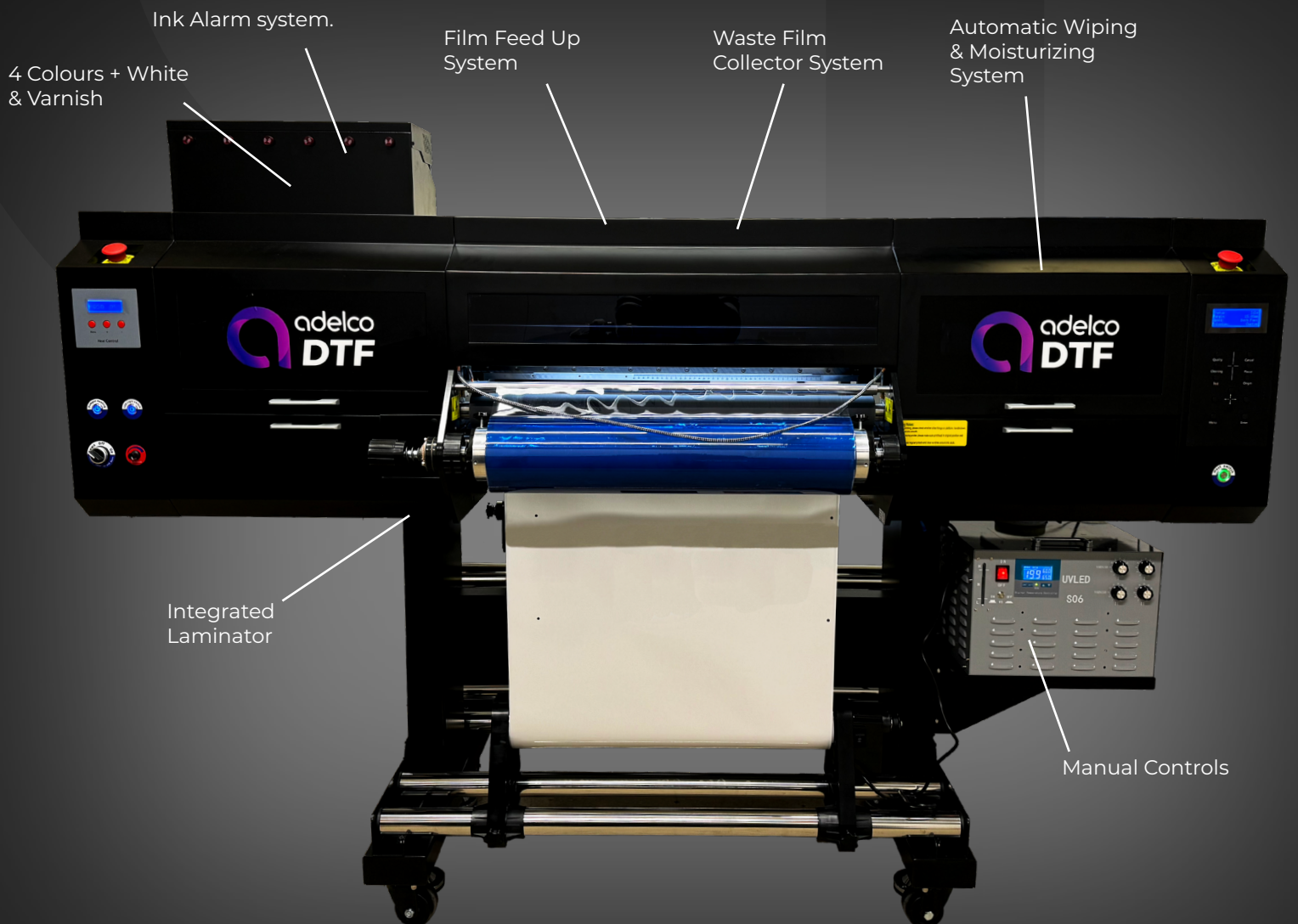

This advanced printer excels in UV DTF roll-to-roll printing, which is particularly suited for transferring UV ink onto special shapes and materials that are not compatible with direct UV ink printing. It offers easy entry into the label market, delivering UV direct print effects without the need for heating or drying processes. UV DTF printing is highly versatile, enabling designs to be transferred onto hard surfaces like metal, leather, wood, paper, plastic, ceramic, and glass, as well as irregular and curved surfaces.

In addition, the printer boasts an advanced automatic wiping and moisturizing system that not only cleans the printhead at startup but also keeps it moist when powered down, effectively preventing blockages during idle periods. With six ink tanks accommodating CMYK colours, white ink, and varnish, it delivers precise shading and rich, expressive detail, meeting a wide range of printing requirements. An automatic ink shortage alarm further guarantees uninterrupted operation. The laminator is equipped with a manual control lift, a silicone rubber roller for optimal laminating pressure, and intelligent heating to ensure consistent, high-quality results. Additionally, the rear side features a paper tension system, a film feed-up system, and a waste film take-up system, all designed to maintain smooth and efficient workflow throughout the entire printing process.

Some additional features include:

- Paper tension system
- Waste film collector system
- Film feed up system
- Ink alarm system
- Spacious laminating press
- Intelligent heating
- Manual control lift

Print Size	90 x 60cm	
Printing Height	15cm	
Print Heads	Epson Three I3200-U1	
Colours	CMYK + White + Varnish	
Ink	Hard UV Ink or Soft UV Ink	
Printing Speed	4 Pass 720 x 1200dpi	8m2/h
	8 Pass 720 x 1800dpi	6m2/h
	12 Pass 720 x 2400dpi	5m2/h
UV LED Light	2pcs 80 x 20mm + 1pcs 30 x 15mm UV LED	
Cooling System	Water Cooling System	
Platform	Vacuum Platform	
Carriage	Auto Up & Down Carriage	
Ink Supply System	CISS Continuous Ink Supply System	
Drying System	Three UV LED Lamps	
Op. Enviroment	Temp: 20-25C Humidity: 40-70RH	
Medium Type	PVC, Plastic, PU, Leather, Steel, Acrylic, Glass Ceramic, Aluminium, ETC	
Connector	Network Connector	
Rip	Digital Factory, Legal Photoprint	
Power Consume	2000 w	
Power Supply	AC 220V, 50-60Hz	
Driven System	Windows XP, 7, 32bits, 64bits, 8, 10	
Package Size	138 x 200 x 92 cm	
GW/NW	350kg / 310kg	

adelco CTS Systems

InkPro - InkJet System



The Adelco InkPro industrial **Computer to Screen** solution, has a **higher resolution** than any other inkjet system on the market. With **superior image integrity**, richer details and smoother halftone transitions. All at a **low price** point, ensuring the best value on the market.

LaserPro - Laser System

An advanced **Computer to Screen** solution. High precision, High productivity, a truly **simple process**. This direct screen laser exposure system produces perfect screen plates.

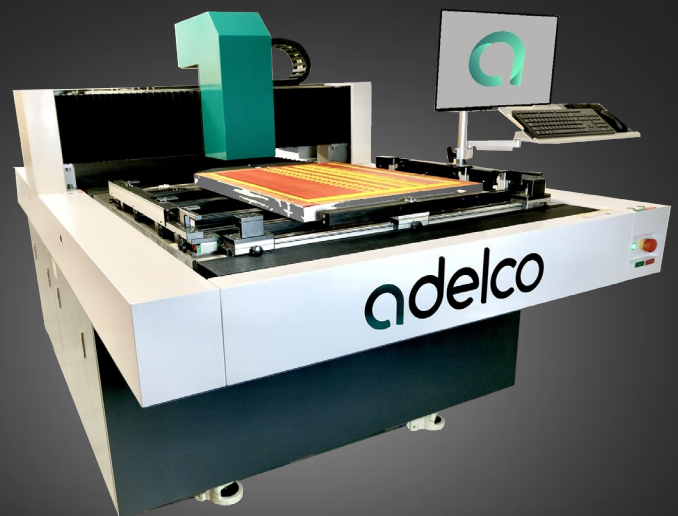

InkPro - InkJet System



Adelco's **InkPro** CTS system, is a high speed, high resolution industrial computer to screen imaging system based on **inkjet printing technology**, that directly generates and exposes opaque images on emulsion - coated screens with UV-blocking ink so that users can reduce the time and effort required for screen preparation.

- **High Resolution**

Utilising the advantages of higher resolution inkjet technology, Adelco **InkPro** has the ability to print computer-to-screen images with richer details and smoother halftone transitions, which are superior to traditional film positives.

- **Optional on board exposure lamp available**

The specially formulated UV-blocking ink also works well on **ALL emulsions on the market.**

- **Easy to integrate**

The screens produced by the **InkPro** are compatible with existing standalone exposure equipment for subsequent exposure. Easy to integrate into current screen printing production lines.

- **High Efficiency**

Exposes screens in less than **60 seconds.**

- **Low Cost**

Elimination of film positives. Litho film is becoming increasingly expensive, and the suppliers on the market are decreasing. One procedure of CTS digital screen making, **replaces five procedures of the conventional process.**

- Professional ColorPRINT server RIP Software for an **efficient workflow.**

- Adjustable frame fixture provides **fast setup for screen frames** upto 635mm x 914.4 mm (25" x 36")

- Print head maintenance module allows **automatic purging, wiping and capping.**

Specifications

Specification	Adelco InkPro
Application	Textile, decals, labels, decorations, etc.
Max Screen Frame Size	635 x 914.4 mm (25" x 36")
Max Image Size (mm)	508 x 660.4mm (20" x 26")
Machine dimensions	1520 x 1700 x 1350 mm (W x D x H)
Screen profile	250.8 mm (2")
Print Technology	DOD piezoelectric inkjet print technology
Print Head	600 DPI Ricoh gen 6 piezo print head
Print Head Control	Auto voltage & temp control, auto print head maintenance, variable droplet size control for grayscale printing.
Exposure time	Under 60 seconds
Resolution	1440 x 1200 dpi
Ink	Black, UV blocking, Ink tank : 1 litre
File Format	Includes PDF, EPS,PS, TIFF, PSD, etc.
Color mode	Monochrome
Connections	15W/20W/25W (optional)
Machine size mm	1600 x 1350 x 1550 2700 x 1550 x 1600
Power requirements	Single Phase 220V,±10% 50/60HZ AC 10 amps max 1000W
Equipment Conditions	Yellow/dark room - Altitude up to 1000m Temperature 16 - 28°C. (61b - 82°F) 40 - 60% relative humidity (recommended)
Software	ColorPRINT server RIP software, Print production software (PPS) Print control software (PCS)

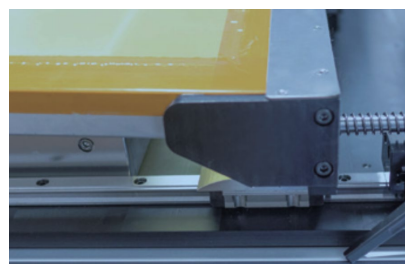

Adjustable Frame Fixture



Locating blocks



Shuttle Gantry Design

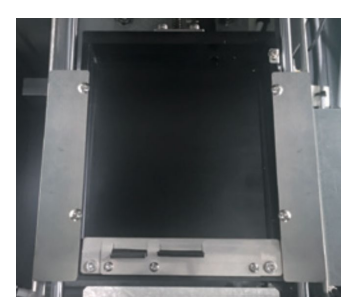

Print Head Maintenance Module

LaserPro - Laser System



Adelco's **LaserPro** machine, is a direct screen laser exposure machine to produce perfect screen plates. Data files are directly read by the computer to screen (CTS) and then converted into images which will be transmitted through **laser beams** onto screens by DMD and lens.

With **no added consumables**, and using Digital Imaging Technology, images are produced by DMD (digital micro-mirror device) which has over **800 thousand or 2 million micrometer** micro-mirrors, enabling clear and sharp square dots. This latest digital exposure system has now become the new standard for the screen printing industry.

- **High Precision and Resolution**

Easy and fast to achieve raster 133LPI and high quality screen dots by the optical 1270dpi, while with the optical 2540dpi, **high definition curved lines** and **perfect FM screen dots** can be realised.

- **High Efficiency**

Three minutes to finish the exposure on screen size 1000mm x 1000mm. **Stencil making efficiency** has been greatly improved due to a lot of time saved by the **accurate exposure alignment** and labour reduction.

- **Low Cost**

Elimination of film positives. Litho film is becoming increasingly expensive, and the suppliers on the market are decreasing. One procedure of the **LaserPro** digital screen making, **replaces five procedures of using the conventional process**.

- **Excellent laser piercing power**

15W, 20W and **25W** three laser powers are optional, and the thickness EOM μm with solvent resistant emulsions and EOM 220 μm with water resistant emulsion can be achieved for some special screen making such as carbon oil and capillary.

- **Compatible processes with the conventional process**

Data files are directly read by the LaserPro and then converted into images which will be transmitted through laser beams onto screens by DMD and lens.

Specification	Adelco Laser	Adelco LaserPro
Application	Textile, decals, labels, decorations, etc.	
Max Screen Size (mm)	900 x 1100mm	1080 x 1200mm
Min Screen Size (mm)	400 x 400mm	400 x 400mm
Max exposure Size (mm)	850 x 950mm	900 x 1000mm
Screen frame thickness	25 - 45 mm	25 - 45 mm
Imaging System	DMD DLP Technology	
Emulsion thickness (EOM)	Solvent resistant emulsion	3 μm - 150 μm
	Water resistant emulsion	3 μm - 350 μm
Exposure time	120 - 240s /M ² , 350 mesh yellow screen	
Resolution	1270dpi	1270dpi
Raster	120LPI	133LPI
File Format	1_bit tiff	1_bit tiff
Focus system	UVLD laser, wavelength 405.5 \pm nm	
Laser Power	20W/25W	15W/20W/25W
Machine size mm	1740 x 1500 x 1480	2700 x 1550 x 1600
Equipment net weight	1200 KG	2200KG
Equipment Conditions	Yellow light room with cleanliness class 10000, temperature 22 \pm 2°C, 40 - 70% relative humidity (no condensation)	
Connections	Single Phase 220V, 50/60HZ, 4KW, Gas 1L/min	

High Resolution

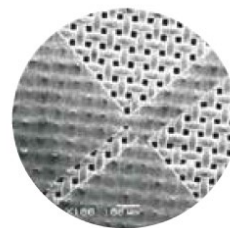

2540dpi

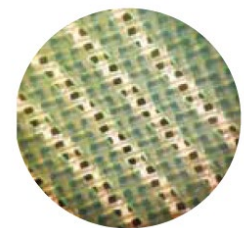

50-micron positive line on 120pw34(300/in)

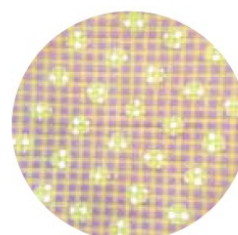

5% halftone dots at 120lpi on 150pw31(380/in)



Four-colour picture

adelco Laser

Introducing an cutting-edge **Computer-to-Screen** solution: Unparalleled precision, unmatched productivity, and a seamlessly intuitive process. Our state-of-the-art direct **screen laser exposure system** crafts flawlessly precise screen plates, setting a new standard in quality and efficiency.

No
Consumables
Needed

Fast & Highly
Efficient



High
Resolution

Compatible with
Conventional
Processes

DMD Exposure
System

Laser - Laser System



Introducing **Adelco's Laser System**, a revolutionary direct screen laser exposure system designed to create **flawless screen plates**. This advanced technology seamlessly translates data files through Computer-to-Screen, transforming them into **high-resolution images**. These images are then transmitted onto screens with precision using **cutting-edge DMD** and lens technology. Witness a new era of perfection in screen plate production.

Experience a consumable-free process powered by state-of-the-art Digital Imaging Technology. Our system employs a Digital Micro-Mirror Device (DMD) boasting an impressive array of over **800 thousand to 2 million micrometer-sized mirrors**, ensuring the creation of impeccably defined square dots with **unparalleled clarity**. This cutting-edge digital exposure technology has firmly established itself as the gold standard within the industry.

- **High Precision and Resolution**

Easy and fast to achieve raster 120LPI and high quality screen dots by the optical 1270dpi, while with the optical 2540dpi, **high definition curved lines** and **perfect FM screen dots** can be realised.

- **High Efficiency**

Three minutes to finish the exposure on screen size 900mm x 1000mm. **Stencil making efficiency** has been greatly improved due to a lot of time saved by the **accurate exposure alignment** and labour reduction.

- **Low Cost**

Elimination of film positives. Litho film is becoming increasingly expensive, and the suppliers on the market are decreasing. One procedure of the **Adelco Laser** digital screen making, **replaces five procedures of using the conventional process**.

- **Excellent laser piercing power**

20W and **25W** twolaser powers are optional, and the thickness EOM μm with solvent resistant emulsions and EOM 150 μm with water resistant emulsion can be achieved for some special screen making such as carbon oil and capillary.

- **Compatible processes with the conventional process**

Data files are directly read by the Adelco Laser and then converted into images which will be transmitted through laser beams onto screens by DMD and lens.

Specifications

	Adelco Laser	Adelco Laser Plus
Application	Textile, decals, labels, decorations, etc.	Textile, decals, labels, decorations, etc.
Max Screen Size (mm)	1000 x 1000	1200 x 1300
Min Screen Size (mm)	400 x 400	400 x 400
Max exposure Size (mm)	850 x 950	1100 x 1250
Screen frame thickness	25 - 45mm	25 - 45mm
Imaging System	DMD DLP Technology	DMD DLP Technology
Emulsion thickness (EOM)	Solvent resistant emulsion 3 μm - 150 μm	Solvent resistant emulsion 3 μm - 150 μm
	Water resistant emulsion 3 μm - 350 μm	Water resistant emulsion 3 μm - 350 μm
Exposure time	120 - 240s /m ² , #350 mesh yellow screen	120 - 240s /m ² , #350 mesh yellow screen
Resolution	1270dpi	1270dpi
Raster	120LPI	120LPI
File Format	1_ bit tiff	1_ bit tiff
Focus system	Wavelength 405 5 \pm nm Auto	Wavelength 405 5 \pm nm Auto
Laser Power	20W/ 25W/ 30W (optional)	20W/ 25W/ 30W (optional)
Machine size mm	1950mm x 1660mm x 1550mm	1960mm x 1800mm x 1500mm
Equipment net weight	1200 KG	1500 KG
Equipment Conditions	Yellow light room with cleanliness class 10000, temperature 22 \pm 2°C, 40 - 70% relative humidity (no condensation)	Yellow light room with cleanliness class 10000, temperature 22 \pm 2°C, 40 - 70% relative humidity (no condensation)
Connections	Single Phase 110/220v, 50/60HZ, 3KW	Single Phase 110/220v, 50/60HZ, 3KW

adelco Laser V

A cutting-edge solution that enables direct **computer-to-screen** processing, offering exceptional **precision** and **productivity**. The straightforward procedure of this advanced **laser exposure system** guarantees **flawless** screen plates.



Laser V - Laser System



Adelco's **Laser V** system utilizes direct screen laser exposure technology to achieve **impeccable screen plate production**. It operates by directly reading data files through the computer to screen (CTS) system, converting them into images, and transmitting them onto screens using laser beams facilitated by the DMD and lens components.

By employing Digital Imaging Technology and **without the need for additional consumables**, this innovative system generates images utilizing the DMD (digital micro-mirror device), which boasts an impressive array of over 800 thousand or 2 million micrometer micro-mirrors. This advanced configuration ensures the production of **crisp and well-defined square dots**. As a result, this cutting-edge digital exposure system has swiftly emerged as the prevailing benchmark within the screen printing industry.

- **High Precision and Resolution**

Effortlessly and swiftly achieve a raster of 133LPI and obtain **high-quality screen dots** through the utilization of an optical resolution of 1270dpi. Alternatively, with an optical resolution of 2540dpi, attain impeccable FM screen dots and high-definition curved lines.

- **High Efficiency**

The exposure process for a screen size of 1000mm x 1000mm can now be completed in just **three minutes**. This remarkable reduction in time, coupled with precise exposure alignment and decreased labor requirements, has significantly enhanced the efficiency of stencil making.

- **Low Cost**

Elimination of film positives. Litho film is becoming increasingly expensive, and the suppliers on the market are decreasing. One procedure of CTS digital screen making, **replaces five procedures of using the conventional process**.

- **Excellent laser piercing power**

Two laser powers are optional: **20W** and **25W**, the thickness EOM (emulsion over mesh) pf 120µm with solvent resistant emulsions and an EOM of 220µm with water resistant emulsion can be achieved for special screen making such as carbon oil and capillary.

- **Compatible processes with the conventional process**

The CTS directly reads data files and subsequently converts them into images. These images are then transmitted onto screens using **laser beams**, facilitated by the DMD and lens components.

Specifications

	Adelco Laser V	Adelco Laser V- XL
Application	Textile, Decals, Labels, Decorations, etc.	Textile, Decals, Labels, Decorations, etc.
Max Screen Size (mm)	1000 x 1000 mm	1200 x 1300 mm
Min Screen Size (mm)	400 x 250 mm	400 x 250 mm
Max exposure Size (mm)	1100 x 1200 mm	1100 x 1200 mm
Screen frame thickness	20 - 50 mm	20 - 50 mm
Imaging System	DMD DLP Technology	DMD DLP Technology
Emulsion thickness (EOM)	Solvent resistant emulsion 3µm - 150µm Water resistant emulsion 3µm - 350µm	Solvent resistant emulsion 3µm - 150µm Water resistant emulsion 3µm - 350µm
Exposure time	120 - 240s / m ² , 350 mesh yellow screen	120 - 240s / m ² , 350 mesh yellow screen
Resolution	1270dpi / 2540dpi (Optional)	1270dpi / 2540dpi (Optional)
Raster	133LPI	133LPI
File Format	1_ bit tiff	1_ bit tiff
Focus system	UVLD laser, wavelength 405 5±nm	UVLD laser, wavelength 405 5±nm
Laser Power	20W/25W (Optional)	20W/25W (Optional)
Machine size mm	1900 x 1417 x 2300 mm / 74.8 x 55.9 x 90.6"	1900 x 1417 x 2300 mm / 74.8 x 55.9 x 90.6"
Equipment net weight	1400 KG	1400 KG
Equipment Conditions	Yellow light room with cleanliness class, temperature 22±2°C, 40 - 70% relative humidity (no condensation)	Yellow light room with cleanliness class, temperature 22±2°C, 40 - 70% relative humidity (no condensation)
Connections	Single Phase 110V/ 220V, 50/60HZ 4KW, Compressor air 0.5 mpa	Single Phase 110V/ 220V, 50/60HZ 4KW, Compressor air 0.5 mpa



adelco

Universal Flash Cure

Incredible value range of state of the art **Flash Cure units** with cutting edge **Quartz Infra Red Lamps** for all your **Screen and Digital printing** requirements

UFC-B-4560-3 on a optional **Movable Stand**



UFC-B-4560-3 on a optional **Oval Frame mount**

- Rapid cure, medium wave quartz lamps
- Variable sizes
- Touch screen interface
- Three and nine independent zones

Discover excellence in printing with Adelco's extensive lineup of high-spec **Flash Cures** tailored to meet diverse applications. Harnessing the latest in **quartz infra-red lamp technology**, our solutions deliver unmatched performance for all your screen printing and digital needs.

Enhance your screenprinting setup with our **optional fixed stands and frames**, designed to accommodate any printing requirement

Model	Compatible Machines	Curing Area	Carbon Fibre
UFC-B-4560-3	Cyclones, Ovals and Matrix	45x60cm	9 x 1500w
UFC-P-4560-3	Cyclones, Ovals and Matrix	45x60cm	9 x 1500w
UFC-B-5070-3	Cyclones, Ovals and Matrix	50x70cm	12 x 1500w
UFC-P-5070-3	Cyclones, Ovals and Matrix	50x70cm	12 x 1500w
UFC-B-6080-3	Cyclones, Ovals and Matrix	60x80cm	12 x 1500w
UFC-P-6080-3	Cyclones, Ovals and Matrix	60x80cm	12 x 1500w
UFC-B-70100-3	Cyclones, Ovals and Matrix	70x100cm	15 x 1500w
UFC-P-70100-3	Cyclones, Ovals and Matrix	70x100cm	15 x 1500w



UFC mounted on an oval frame mount



UFC mounted on its fixed stand

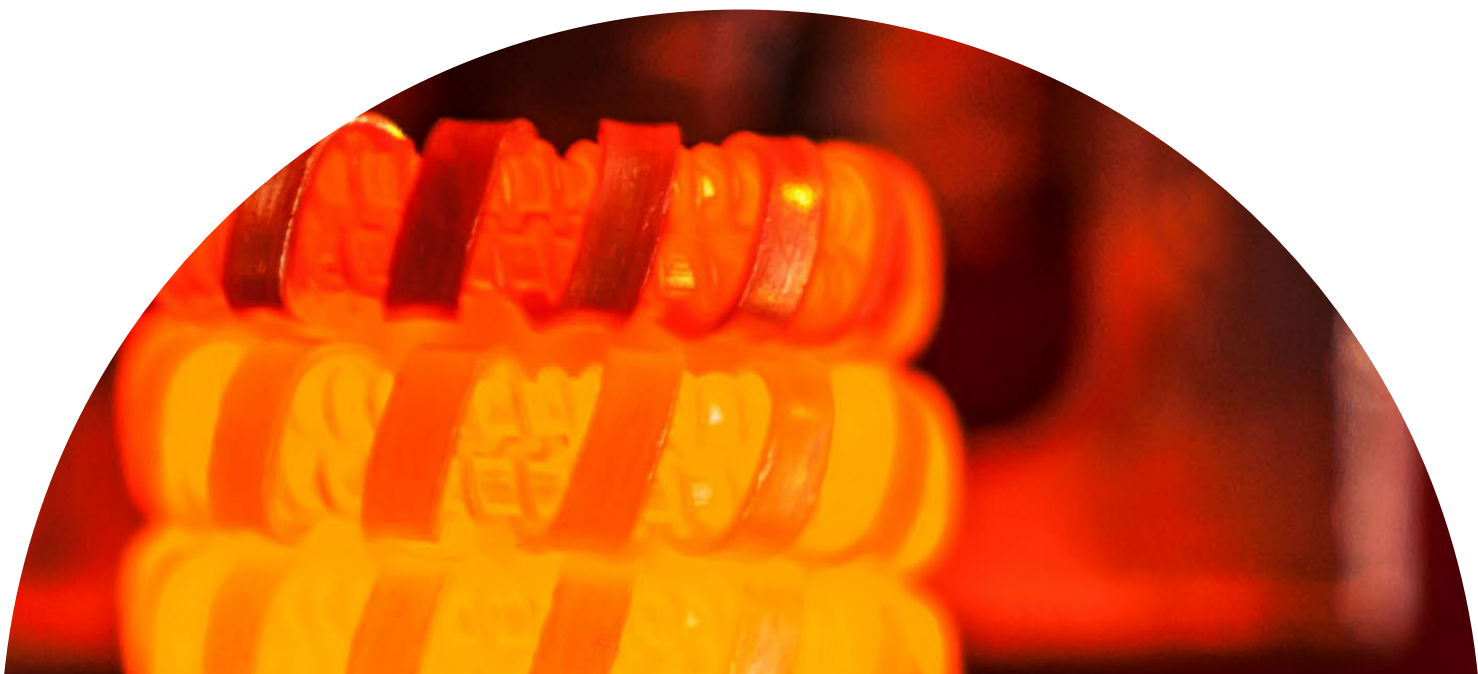

adelco HAFC

A unique combination **Hot air and Quartz IR flash cure** unit with air extraction provides **unmatched** intermediate drying of **water based, Plastisol and Digital ink systems**.
Featuring easily adjustable variable airflow via the **intuitive control panel**.



- Rapid cure, medium wave quartz lamps
- Stand mounted
- Hot air recirculation and extraction
- Three independent zones

Achieve rapid curing with our **Hot Air Flash Cure**. A stand-mounted medium-wave quartz lamp flash cure system.

It features **high-velocity variable airflow**, along with **hot air extraction and recirculation**, along with variable power output for optimal performance.

The **HAFC** is equipped with **three independent zones** and offers universal adjustability to seamlessly interface with most automatic and manual carousels.

Model	Compatible Machines	Curing Area
HAFC-5070-3	Cyclones, Ovals and Matrix	50x70cm
HAFC-6080-3	Cyclones, Ovals and Matrix	60x80cm



- Optional PIR sensor for automatic temperature setting.
- Variable air flow adjustable through control panel
- Filter tray easy to clean whilst the machine is working

adelco ANCILLARIES

adelco
CYCLONE SEMI-AUTO

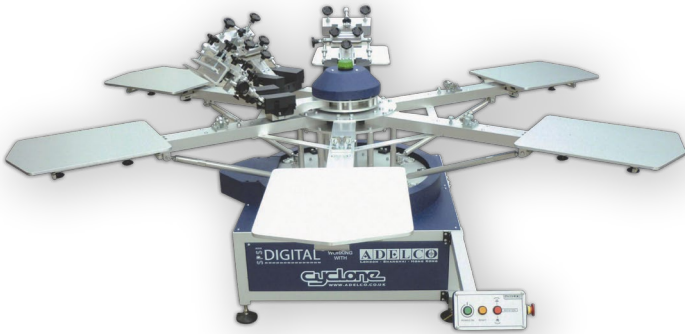

adelco
MANUAL CAROUSEL

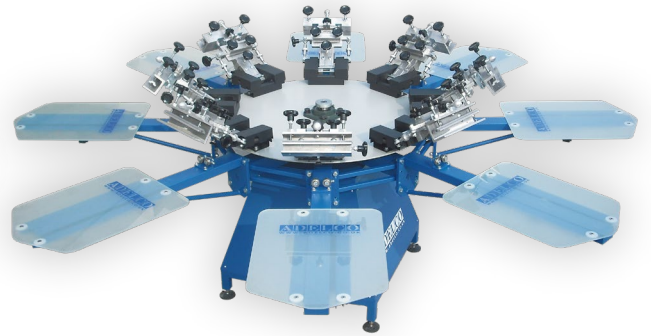

adelco
TEMPERATURE
MAPPING KITS



adelco
PRE-REGISTRATION
SYSTEM



adelco
TABLE FLASH

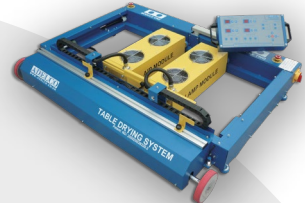

adelco
AUTO FLOCK UNIT



adelco
FLOCK CLEANER



adelco
INK MIXER



adelco
HOT IRON



adelco
HEAT PRESS STATION

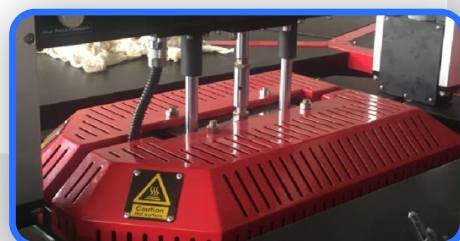

Stretching Solutions

**Auto High Precision
Stretching solution -
HT-1020EA-WZ**



**Electrical High Precision
Stretching solution -
HT-1020EM**



**Manual Stretching solution -
HT-1515MS**

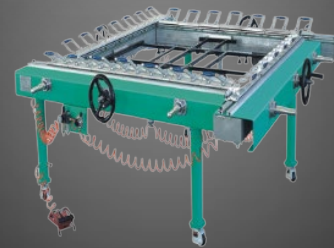

Coating Systems

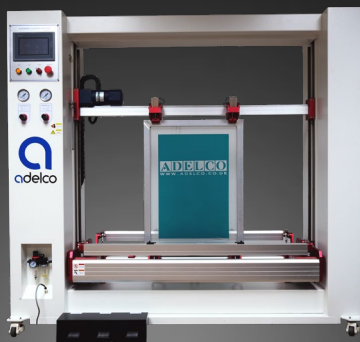

**Auto Screen Coating System
HC-1010AD/ HC-1313AD**

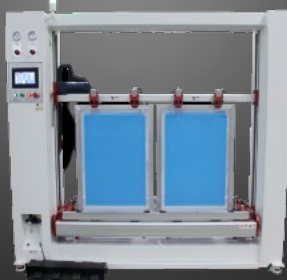

**Auto Double Screen Coating
System HC-6510ADD**

Exposure Units



Horizontal self contained exposure units. Comes in 3.5KW (Hg 3w lamp) & 480KW (LG LED Lamp)

Drying Equipment



Vertical Screen drying cabinet - HD-1010FV



Horizontal Screen drying cabinet - HD-1010FL

Screen Washing Systems

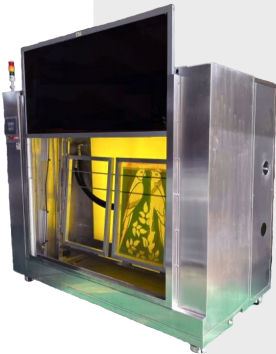

Auto Screen Washing & Developing Systems - HW-1010AL



Manual Screen Wash-out booth - HW-1010M



www.adelco.co.uk

UK Unit 18 Highview, Highstreet, Bordon, Hants., England, GU35 0AX

Tel: +44(0)1420 488 388

Fax: +44(0)1420 476 445

CHINA No. 445, Wangshi Road, Lujia, Kunshan, 215300, China

Tel: +86(512)5747 0308

